

# Report

## Fjellkontrollboring Sukkertoppen

Carried out by

**DS Entreprenør AS**  
**Postboks 844**  
**1671 Kråkerøy**

08.10.2019



# Table of contents

Definition of the project.....	3
Procedural method-drilling.....	4
Used equipment .....	5
Kompressor datasheet (Atlas Copco)   Hydraulic power pack (Morath GmbH) .....	5
Rotary head (Morath GmbH)   Down-the-hole-hammer (Morath GmbH).....	6
Drill bit (Knödseder GmbH).....	7
Drilling rig/ setup (Custom made) .....	7
Attachments .....	8

## Definition of the project

The purpose of the project was to map soil- and rock conditions as basis for the design of foundations for avalanche supporting structures. The pictures below show the coordinates and steepness of the mountain, called Sukkertoppen. According to the coordinates there are 30 holes to drill. While working, drilling on the side, Øyvind Hellum from the Longyearbyen lokalstyre and Marit Bratland Pederson from Rambøll Norge AS decided to drill one additional hole due to the underground conditions which is marked with hole number 'TP129 additional'.

Therefore it comes to a total number of 31 holes. Hole Number TP100, TP101 and TP103 until TP106( including) were drilled with an angle of 30° from horizontal. TP102, TP119=T6 and T5 have been drilled vertical. We mounted a metal pipe in the holes which were drilled vertical, which enables the installation of a temperature sensor . All the other holes have been drilled with an angel of 50° from horizontal.

The depth of the holes varies between 7,5m and 12m depending on the ground Material. In addition to the Drilling-log, which gives you information about the correlation between time and drill-speed, we also took pictures and made movies from almost every hole. Further details can be found in the section attachments.

The drilling work has been carried out between the 2.09.2019 and 3.10.2019.

## Procedural method-drilling

### Rotary percussive drilling (down the hole hammer)

With down-the-hole hammer drilling, the drill principle consists of a combination of percussion and rotation. Unlike the top hammer, here the hammer drill is located directly in the borehole. These devices, known as 'down-the-hole hammers', are connected to the rotating drill pipes. The drilling Setup is a combination of Morath GmbH (<https://www.morath.eu/de/>), Knödseder GmbH (<https://knoedseder.com/home/>) and custom made parts. For the operating air pressure we used 12bar. The speed of rotation depends on the material, for solid rock the speed is more or less constant and about 60 1/min. Whereupon drilling in soil or loose material, the rotation speed is much higher and about 100 1/min, otherwise the hammer will get stuck.



# Used equipment

## Kompressor datasheet (Atlas Copco)

<b>Model</b>	<b>XAHS 186 Dd</b>
Free Air Delivery @ Normal Working Pressure (ISO1217 standard)	10.5m <sup>3</sup> /min
	371CFM
Normal Working Pressure	12bar
	175psig
Minimum / Maximum Unloading Pressure	4 / 13.5 bar
Compression Stages	1
Air Receiver Capacity	42L
Compressor Oil Capacity	23.5 L
Approximate Air Outlet Temperature	95°C (Standard)
Typical oil content of compressed air	<5 mg/m <sup>3</sup>
Fuel Tank Capacity	175 L
Outlet Valve Configuration	3 x 3/4" G, 1 x 1.5" G
Nominal working condition	Inlet pressure 1bar, Humidity0%, Temp20 °C
Sound Pressure Level (ISO2125 standard)	71 dB(A)
Maximum Ambient Temperature at sea level	45°C
Maximum Altitude	3000m
Minimum Starting Temperature	-10 °C / -20 °C (with assist)
Diesel Engine Data	Deutz TCD2013L04
Horsepower Developed @ Rated Speed	104KW
Cylinders	4
Cooling System	PARCOOL engine coolant
Engine Coolant Capacity	19L
Engine Oil Capacity	10L
Unloaded Speed / Maximum Loaded Speed	1700 / 2100RPM
<b>Dimensions</b>	
Length	4480mm (with towbar)
Width	1701mm
Height	1661mm
Weight ( filled with oil & coolant , Initial fuel )	1900kg

## Hydraulic power pack (Morath GmbH)

### Technische Daten

### Technical data

#### Antrieb // Drive

Dieselmotor // Diesel motor	Kubota D1703-M-E3B
Abgasrichtlinien // Emission regulations	Interim Tier 4 / Stufe 3A
Zylinderzahl // Number of cylinders	3
Leistung nach SAE J 1995 Power according to SAE J 1995	26 KW
Drehzahl // Speed	2.800 U/min
Hubraum // Capacity	1647 ccm
Dieseltankvolumen Diesel tank capacity	60 l
Batteriespannung // Battery voltage	12 V

#### Hydraulikanlage // Hydraulic system

Anzahl Pumpenkreise // Number of pump circuits	1
Max. Förderleistung // Max. Flow rate	80 l/min
Systemdruck // System pressure	180 bar
Hydrauliktankvolumen // Hydraulic tank volume	95 l

#### Abmessungen // Dimensions

A / A1	1.650 / 2.110 mm
B / B1	800 / 1.130 mm
C / C1	1.040 / 1.130 mm
Gesamtgewicht // Total weight	500 kg

## Rotary head (Morath GmbH)

### Technische Daten

### Technical data

#### Getriebe // Transmission

Motortyp* Motor type*	TE 080**	TE 130
max. Betriebsdruck max. operating pressure	200 bar	200 bar
max. Drehmoment max. torque	930 Nm	1.488 Nm
max. Drehzahl max. speed	160 1/min	101 1/min
max. Schluckstrom max. absorption capacity	...60 l/min	...60 l/min

#### Abmessungen // Dimensions

A / A1	650 / 150 mm
B / B1	140 / 15 mm
C / C1	160 / 20 mm
D / D1	90 / 70 mm
E / E1	57,8 / 34,2 mm
F Anschlussgewinde Connecting thread	API 2 3/8" i., GG46i., Rd50x1/6"a.
G Spülanschluss Flusher	G 1" i., UM38
Gesamtgewicht Total weight	29 kg

## Down-the-hole-hammer (Morath GmbH)

### Technische Daten

### Technical data

#### Betriebsdruck Operating pressure

6 bar	1.750 1/min
10 bar	2.300 1/min
13 bar	2.700 1/min
16 bar	2.900 1/min

#### Schlagzahl Impacts

#### Abmessungen // Dimensions

L	752 mm
D	63 mm
SW	50 mm
Kolbendurchmesser Piston diameter	47 mm
Bohrkronendurchmesser Drill bit diameter	76 mm
Anschlussgewinde Connecting thread	Gg46a.*
Gewicht ohne Bohrkronen Weight without drill bit	12 kg

**Drill bit (Knödlseeder GmbH)**



**Drilling rig/ setup (Custom made)**



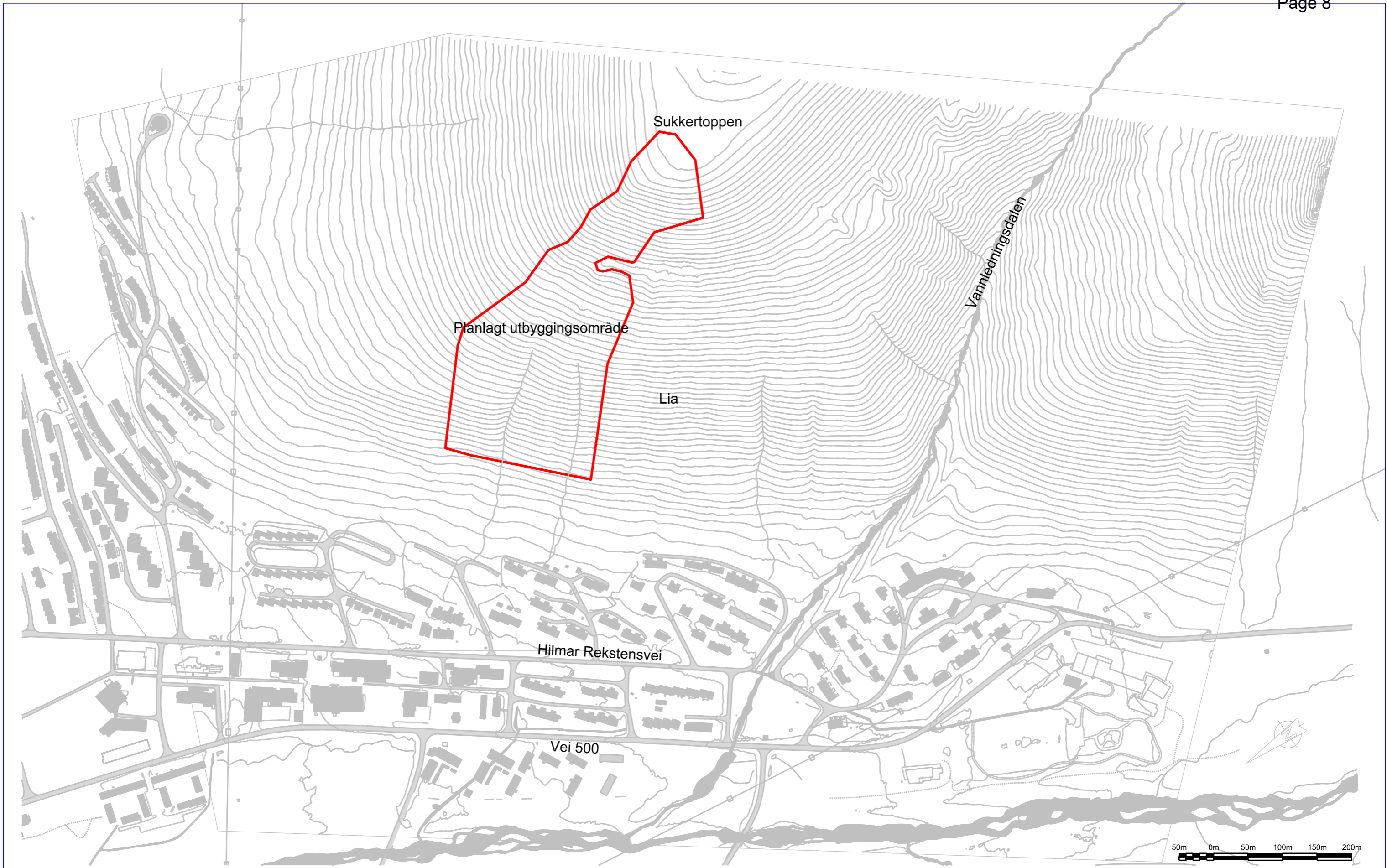

Forklaring:  
 Koordinatsystem: UTM 33  
 Høydesystem: Longyearbyen  
 Kartdata: Norsk Polarinstitutt  
 Terrengmodell: SHG

6		Status:	<b>Anbudsdokument</b>	
5		Prosj. HNT: 18247	Prosj. Skred AS: 18241	
4		Design: AJ	Tegn.: AJ	QC: -
3		Kontakt NVE: Silan Bue Kanstad		
2		Prøve: 160359-5289/160359-18748		
1		Dato: 01/07/2019		
△	Breytingar:	Dags.:	Godkjent: Sign. Arni Jonsson	



Norges Vassdrags- og Energidirektorat NVE  
 Longyearbyen  
 Sukkertoppen - Støtteforbygninger  
 Prøveboring i Lia  
 Situasjonsplan  
 Original: ISO A1 Tegnr. nr.: Utg.:  
 Nr.: 1:2500 18241-13-01 0



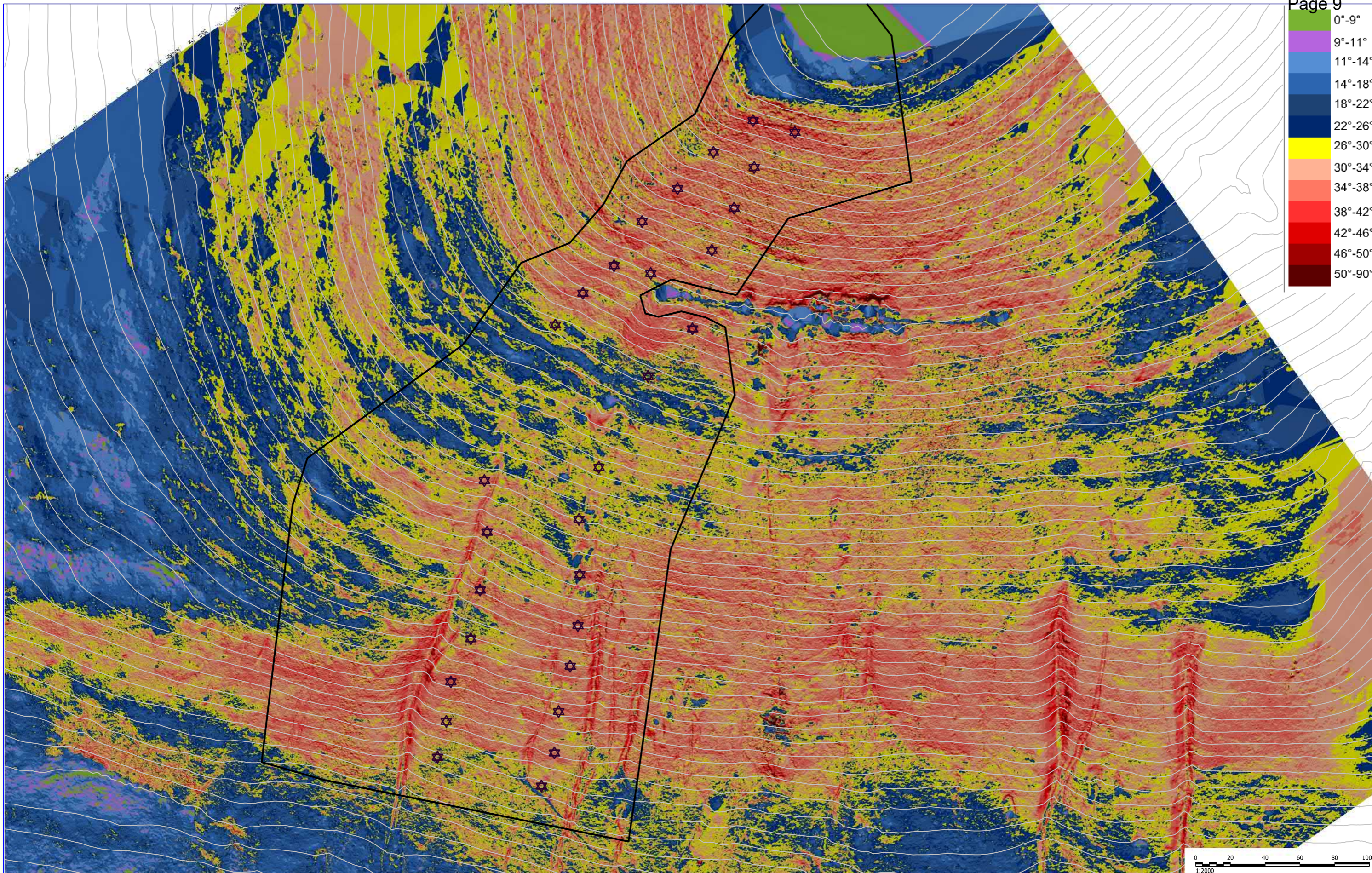

Forklaring:  
 Koordinatsystem: UTM 33  
 Høydesystem: Longyearbyen  
 Kartdata: Norsk Polarinstitutt og UNIS  
 Terrengmodell: SHG  
 Høydekurveavstand: 5 m

★ Planlagt borehull

6		Status:	Anbudsdokument	
5		Prosj. HNIT:	18247	Prosj. Skred AS: 18241
4		Design:	AJ	Tegn.: AJ
3		Kontakt NVE:	Sitan Bue Kanstad	
2		Prosj.:	160359-5289/160359-18748	Dato: 01/07/2019
1		Godkjent:	Sign. Arni Jonsson	
△	Breytingar:	Dags.:		



Norges Vassdrags- og Energidirektorat NVE  
 Longyearbyen  
 Sukkertoppen - Støtteforbygninger  
 Prøveboring i Lia  
 Helningskart-HMS  
 Original: ISO A1  
 Tegnr. nr.: 18241-13-02  
 Utg.: 0

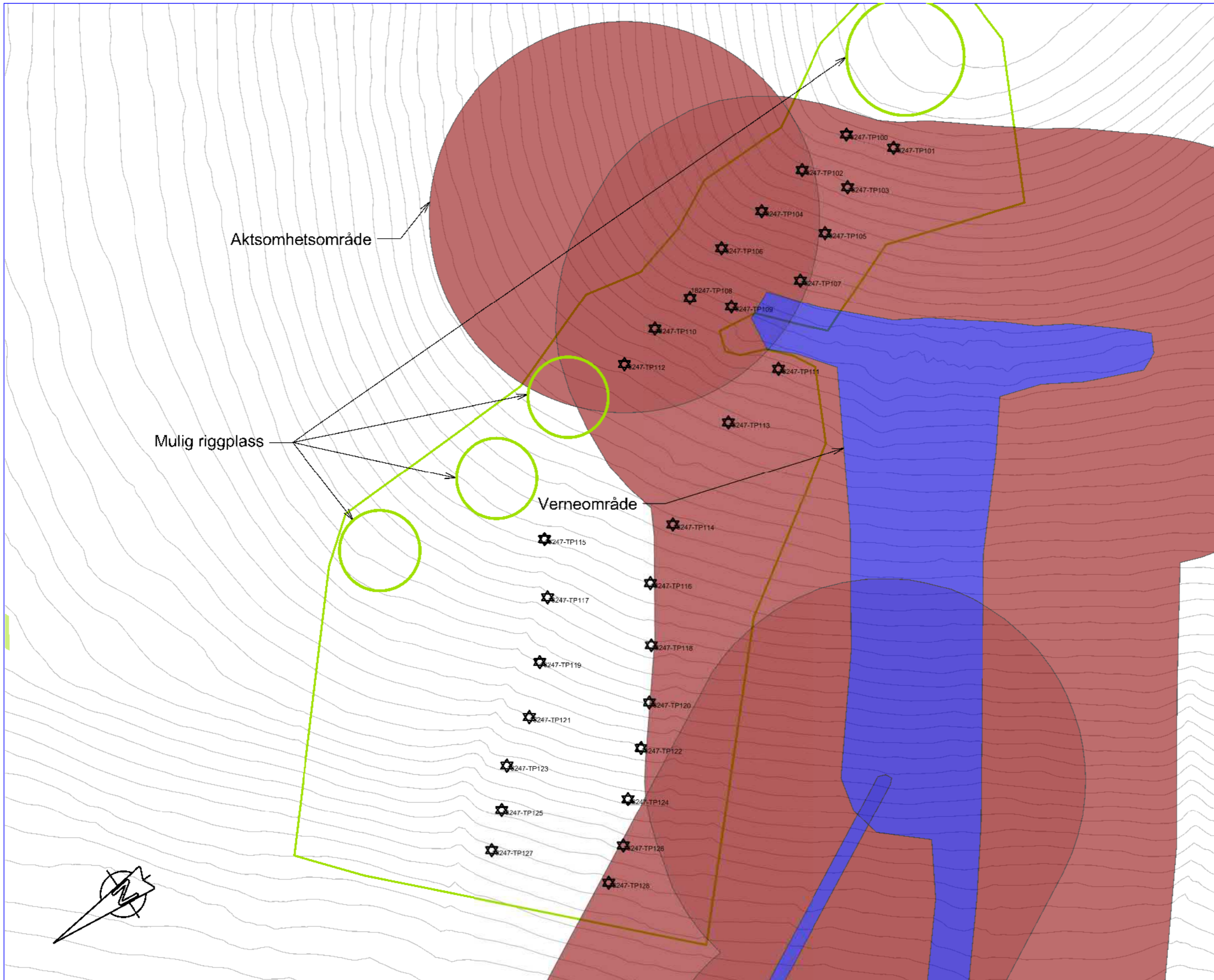

Koordinatliste

Linje	Øst	Nord
18247-TP100	514923.2217	8682060.7773
18247-TP101	514903.8564	8682044.9664
18247-TP102	514921.4090	8682089.8695
18247-TP103	514900.8082	8682075.7060
18247-TP104	514916.0748	8682118.7665
18247-TP105	514888.2453	8682098.5564
18247-TP106	514912.3129	8682146.3725
18247-TP107	514875.7595	8682122.9602
18247-TP108	514904.8107	8682170.7768
18247-TP109	514884.9936	8682159.3688
18247-TP110	514898.0703	8682197.8337
18247-TP111	514845.0980	8682158.0060
18247-TP112	514892.1772	8682221.3096
18247-TP113	514837.3752	8682194.6052
18247-TP114	514810.7885	8682247.7573
18247-TP115	514842.3225	8682306.0568
18247-TP116	514792.8451	8682274.2908
18247-TP117	514817.0860	8682321.8156
18247-TP118	514766.4964	8682292.1670
18247-TP119	514792.1387	8682344.1685
18247-TP120	514743.1038	8682309.8307
18247-TP121	514772.2346	8682364.6114
18247-TP122	514726.5653	8682326.8502
18247-TP123	514758.5569	8682388.2222
18247-TP124	514709.0341	8682347.2908
18247-TP125	514741.4604	8682403.3830
18247-TP126	514690.9094	8682362.8973
18247-TP127	514727.4920	8682419.3631
18247-TP128	514679.5776	8682379.9235

Aksomhetsområde

Mulig riggplass

Verneområde

18247-TP127 Plassering av prøvehull med nummer

Forklaring:  
 Koordinatsystem: UTM 33  
 Høydesystem: Longyearbyen  
 Kartdata: Norsk Polarinstitutt  
 Terrengmodell: SHG  
 Høydekurveavstand: 5 m

6		Status:	Anbudsdokument
5		Prosjekt: NIT: 18247	Prosjekt: Skred AS: 18241
4		Design: AJ	Page: AJ
3		Kontakt NVE: Silian Bue Kamsland	QC: -
2		Prosjekt: 180359-5288/160359-18748	Date: 01/07/2019
1		Dokument: Brevtinger	Design: Sign. Ami Jonsson

  
  

Norges Vassdrags- og Energidirektorat NVE  
 Longyearbyen  
 Sukkertoppen - Støtteforbygninger  
 Prøveboring i Lia  
 Plan-Geometri  
 Oriental: ISO A1  
 Utsnitt: 1:1000  
 Tittel: 18241-13-03  
 Side: 0

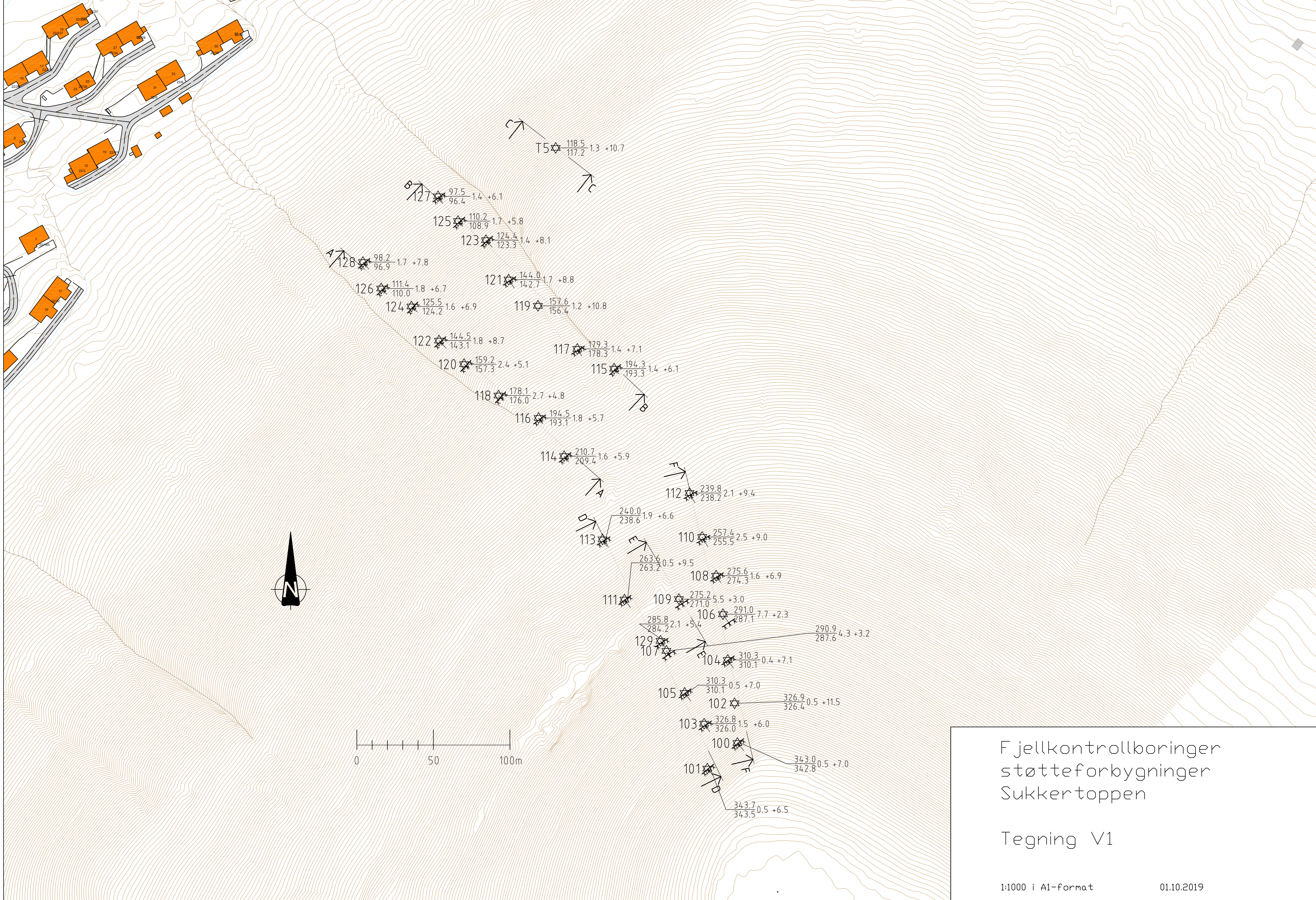

Fjellkontrollboringer  
støtteforbygninger  
Sukkertoppen

Tegning V1

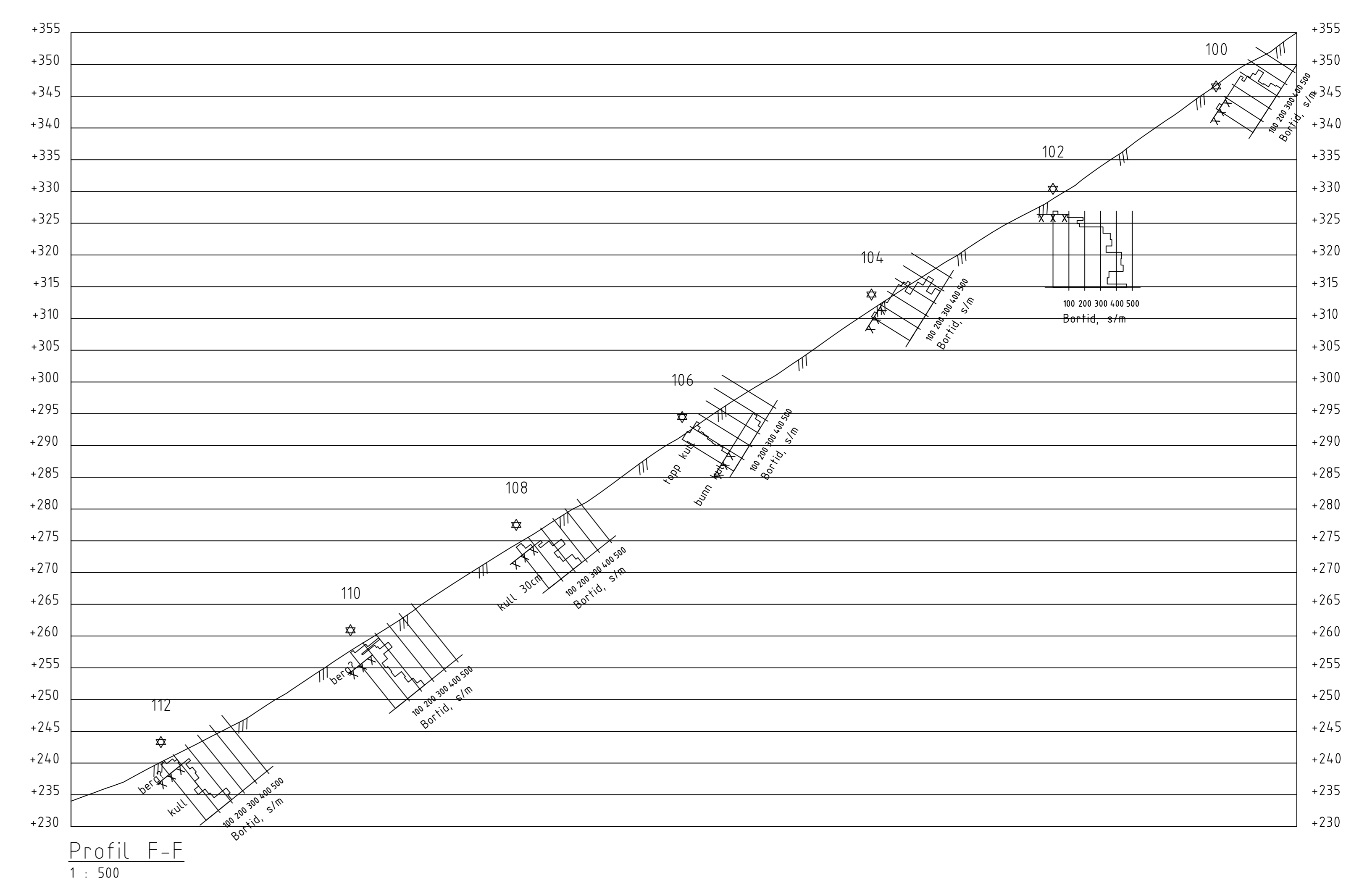
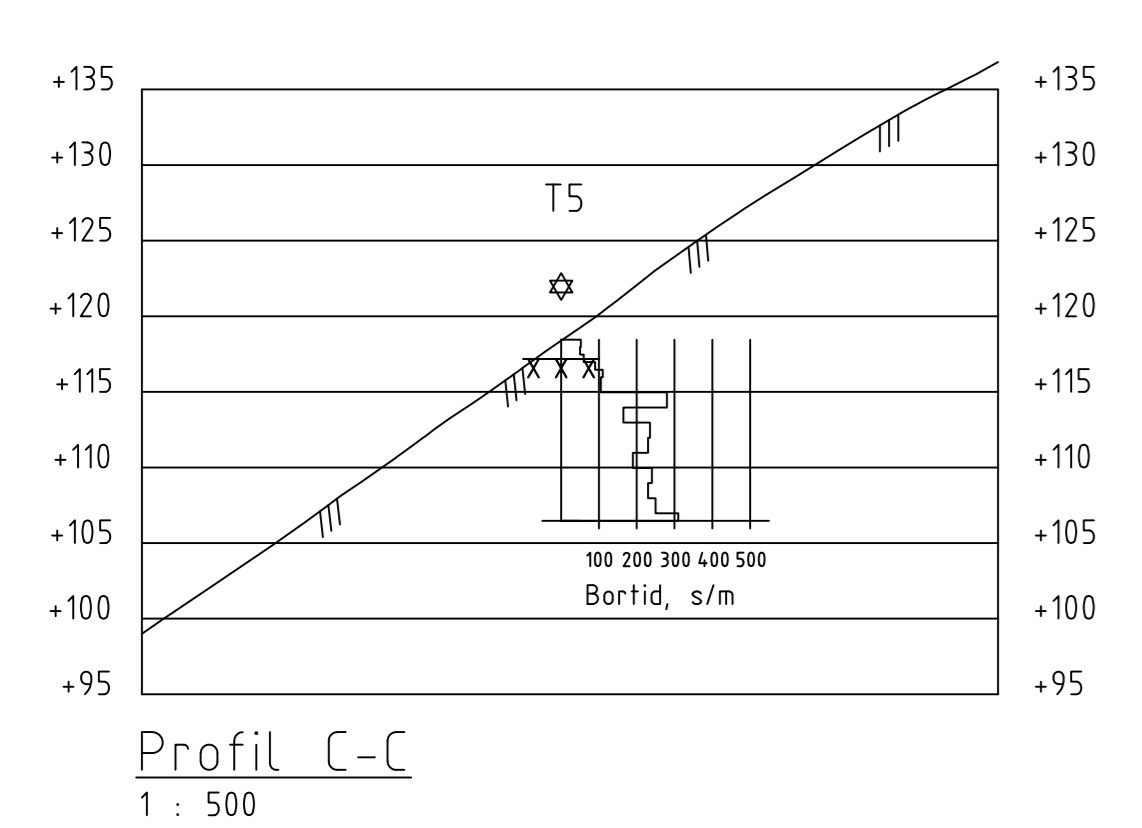
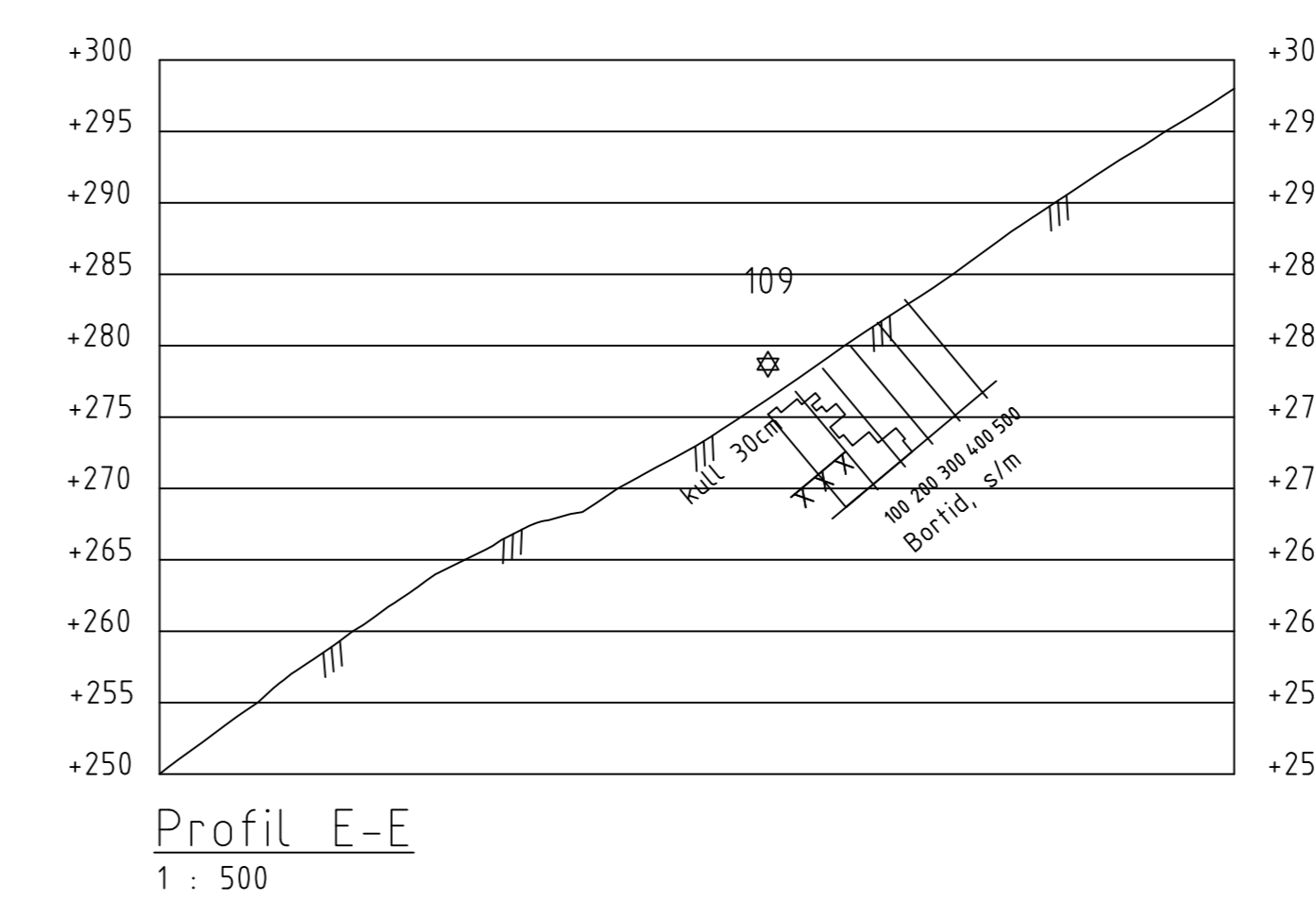
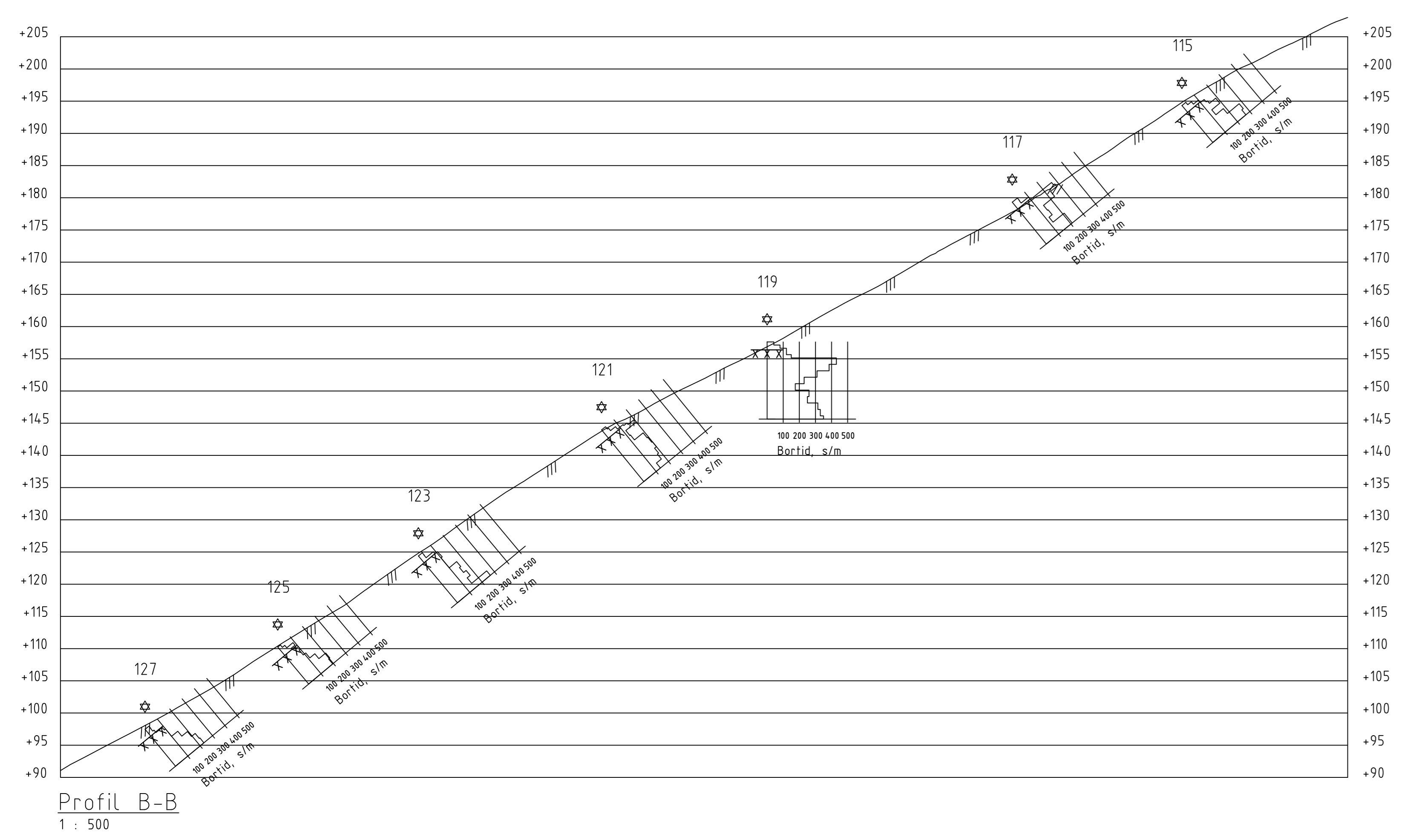
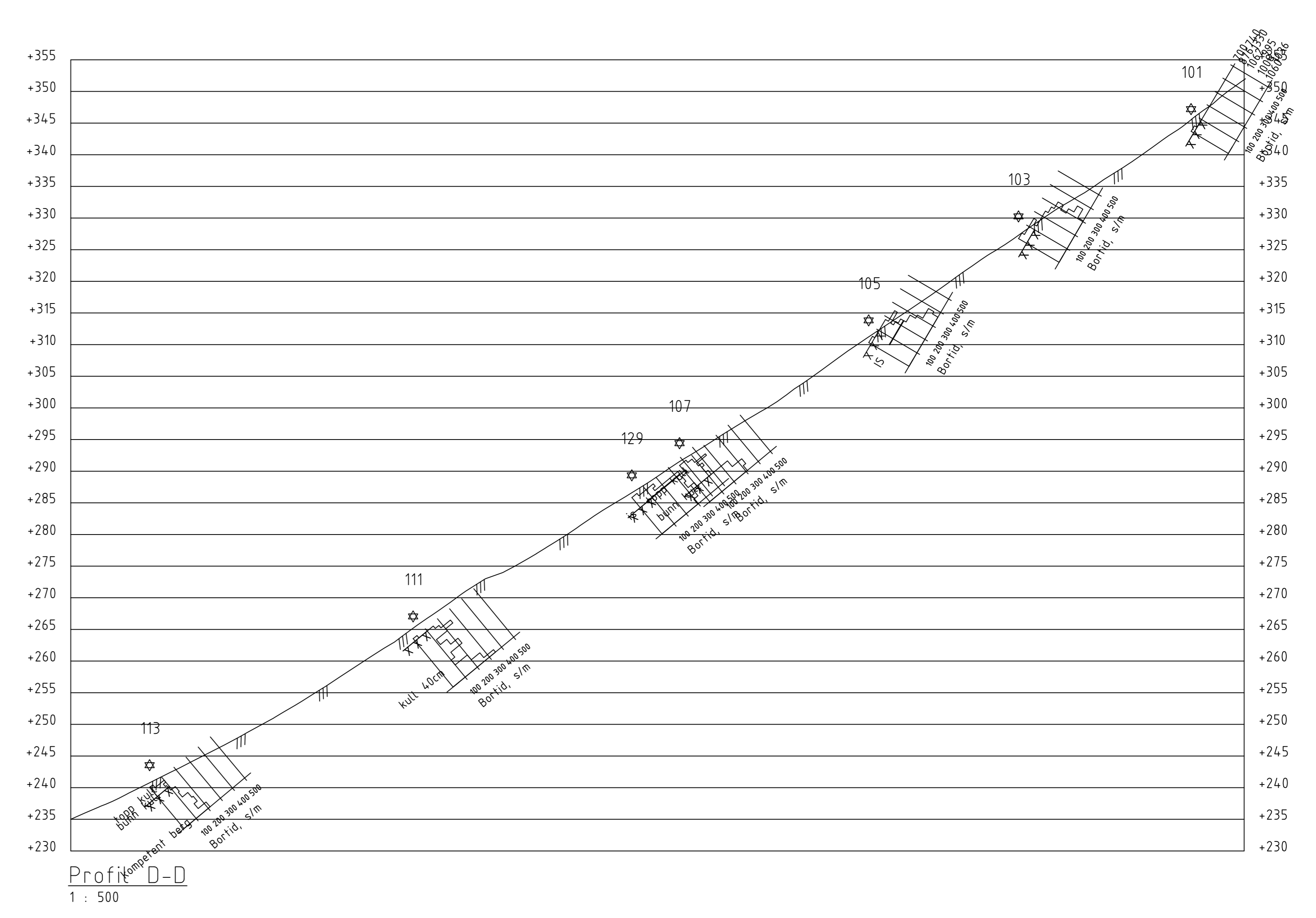
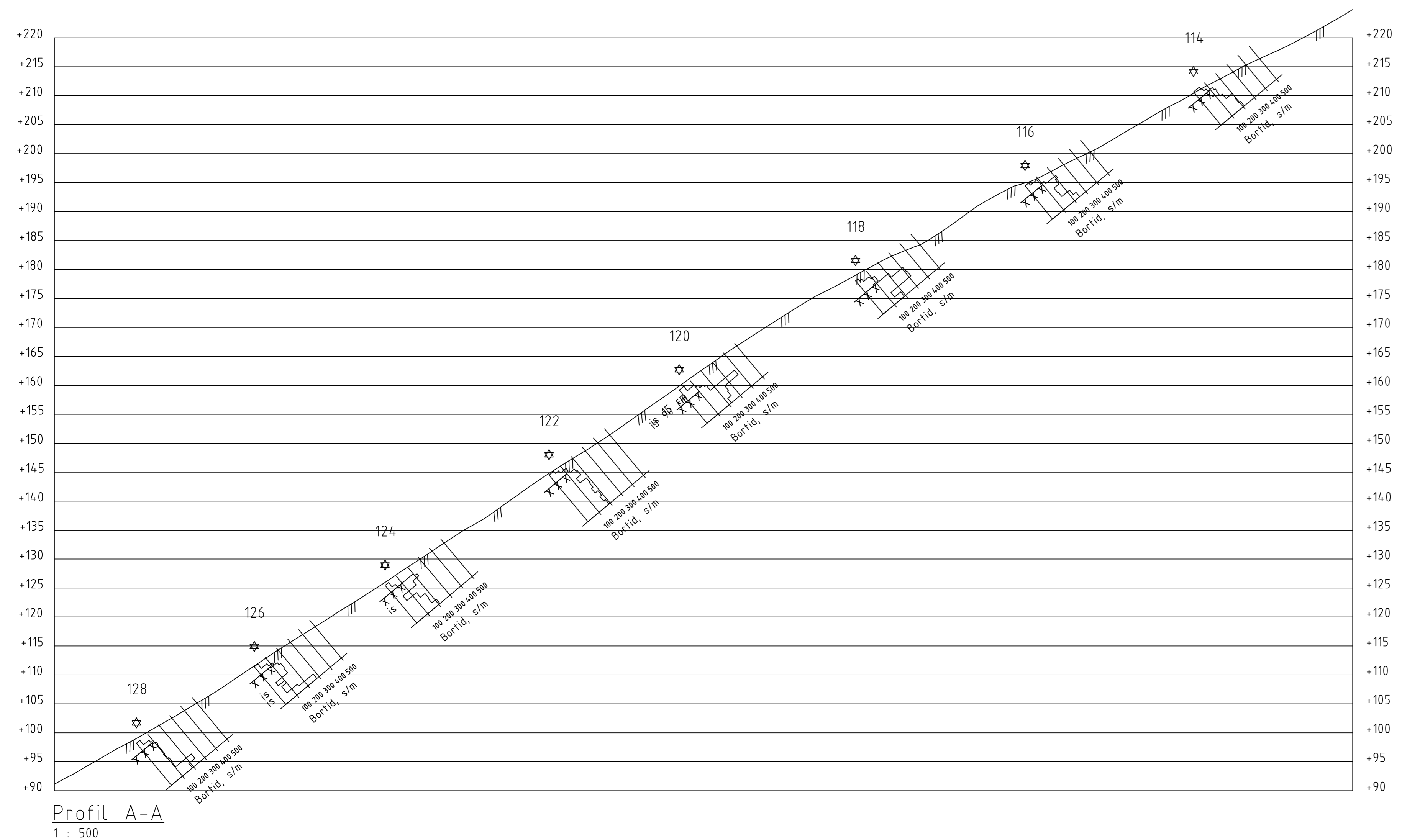

Terrengprofiler  
støtteforbygninger  
Sukkertoppen.  
Profiler iht tegning V1  
  
Tegning V2  
  
1:500 i A0 01.10.2019

### Borpunktliste grunnundersøkelser - Skredsikring støtteforbygninger Sukkertoppen.

Borhull	N	Ø	Z	Metode	Stopp	Løsm	Fjell	Dato	Kommentar
100	8682061.12	514919.79	343.04	Fjell Tolk	94	0.5	7	06.09.2019	
101	8682044.40	514900.12	343.71	Fjell Tolk	94	0.5	6.5	05.09.2019	
102	8682087.06	514917.92	326.92	Fjell Tolk	94	0.5	11.5	06.09.2019	
103	8682073.76	514898.03	326.76	Fjell Tolk	94	1.5	6	07.09.2019	
104	8682115.37	514913.48	310.27	Fjell Tolk	94	0.4	7.1	10.09.2019	
105	8682093.87	514885.29	310.33	Fjell Tolk	94	3.1	4.4	10.09.2019	
106	8682145.24	514910.34	290.97	Fjell Tolk	94	7.7	2.3	11.09.2019	
107	8682121.32	514873.40	290.93	Fjell Tolk	94	4.3	3.2	13.09.2019	
108	8682170.40	514905.88	275.57	Fjell Tolk	94	1.6	6.9	17.09.2019	
109	8682155.10	514881.56	275.20	Fjell Tolk	94	5.5	3	12.09.2019	
110	8682195.69	514896.75	257.41	Fjell Tolk	94	2.5	9	18.09.2019	
111	8682154.77	514846.02	263.55	Fjell Tolk	94	0.5	9.5	17.09.2019	
112	8682224.41	514888.49	239.80	Fjell Tolk	94	2.1	9.4	18.09.2019	Usikker plassering, tatt med håndholdt GPS
113	8682194.11	514831.66	240.05	Fjell Tolk	94	1.9	6.6	18.09.2019	
114	8682248.45	514806.55	210.67	Fjell Tolk	94	1.6	5.9	19.09.2019	
115	8682305.60	514839.25	194.33	Fjell Tolk	94	1.4	6.1	19.09.2019	
116	8682273.42	514789.87	194.45	Fjell Tolk	94	1.8	5.7	19.09.2019	
117	8682318.48	514815.18	179.33	Fjell Tolk	94	1.4	7.1	20.09.2019	
118	8682288.04	514763.69	178.06	Fjell Tolk	94	2.7	4.8	20.09.2019	Usikker plassering, tatt med håndholdt GPS
119	8682346.65	514789.45	157.64	Fjell Tolk	94	1.25	10.75	23.09.2019	
120	8682308.52	514741.17	159.19	Fjell Tolk	94	2.4	5.1	25.09.2019	
121	8682363.81	514770.31	143.98	Fjell Tolk	94	1.7	8.8	23.09.2019	
122	8682323.92	514724.82	144.51	Fjell Tolk	94	1.8	8.7	24.09.2019	
123	8682389.53	514755.49	124.40	Fjell Tolk	94	1.4	8.1	24.09.2019	
124	8682346.21	514706.77	125.47	Fjell Tolk	94	1.6	6.9	24.09.2019	
125	8682402.01	514737.24	110.25	Fjell Tolk	94	1.7	5.8	24.09.2019	
126	8682357.98	514687.01	111.41	Fjell Tolk	94	1.8	6.7	25.09.2019	
127	8682418.19	514724.19	97.49	Fjell Tolk	94	1.4	6.1	25.09.2019	
128	8682375.21	514675.12	98.21	Fjell Tolk	94	1.7	7.8	25.09.2019	
129	8682127.84	514869.56	285.84	Fjell Tolk	94	2.1	5.4	11.09.2019	
T5	8682449.79	514801.04	118.47	Fjell Tolk	94	1.3	10.7	25.09.2019	

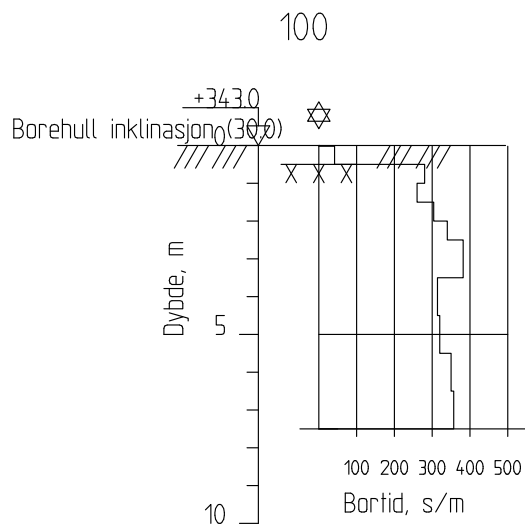

## Støtteforbygninger Sukkertoppen

Rapport nr.

Figur nr.

Fjellkontrollboring

M = 1 : 200

Dato boret : 06.09.2019

Borhull 100

Posisjon: X 8682061.12 Y 514919.79

Tegner

Dato:

Kontrollert

Godkjent

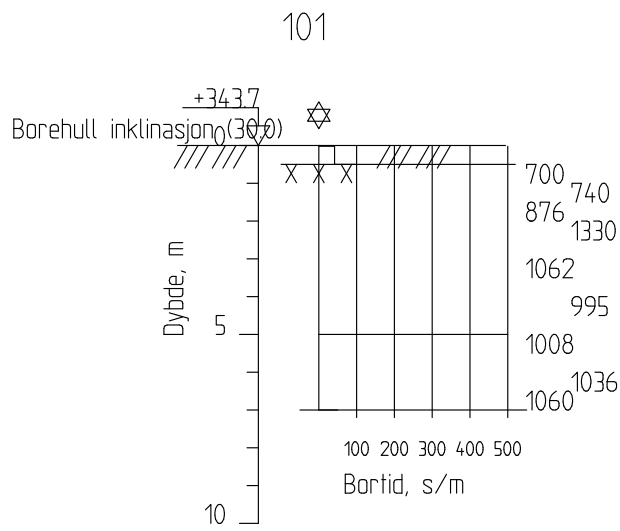

## Støtteforbygninger Sukkertoppen

Rapport nr.

Figur nr.

Fjellkontrollboring

M = 1 : 200

Dato boret :05.09.2019

Borhull 101

Posisjon: X 8682044.40 Y 514900.12

Tegner

Dato:

Kontrollert

Godkjent

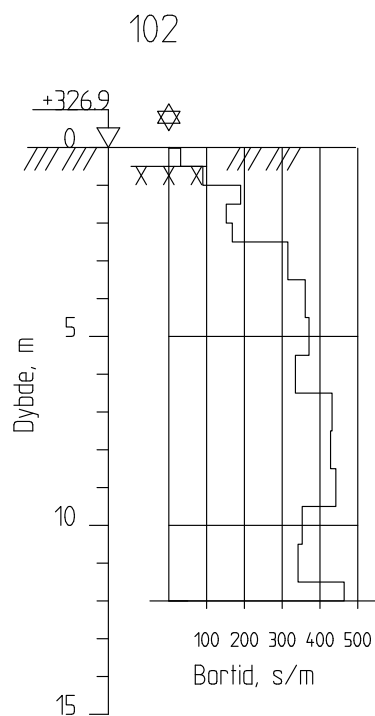

## Støtteforbygninger Sukkertoppen

Rapport nr.

Figur nr.

Fjellkontrollboring

M = 1 : 200

Dato boret :06.09.2019

Borhull 102

Posisjon: X 8682087.06 Y 514917.92

Tegner

Dato:

Kontrollert

Godkjent



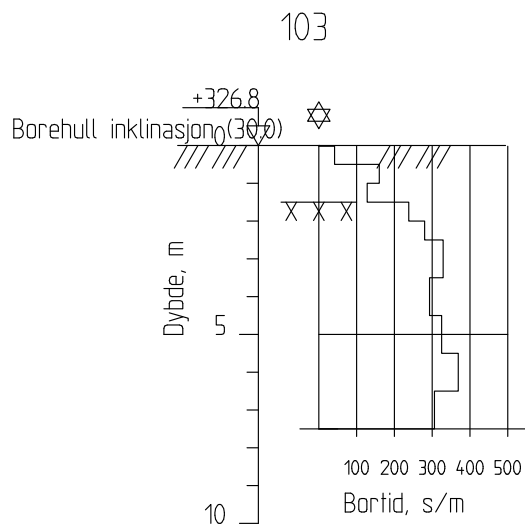

## Støtteforbygninger Sukkertoppen

Rapport nr.

Figur nr.

Fjellkontrollboring

M = 1 : 200

Dato boret : 07.09.2019

Borhull 103

Posisjon: X 8682073.76 Y 514898.03

Tegner

Dato:

Kontrollert

Godkjent

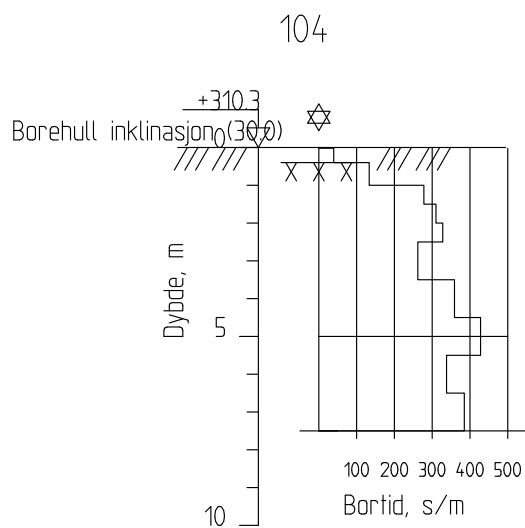

## Støtteforbygninger Sukkertoppen

Rapport nr.

Figur nr.

Fjellkontrollboring

M = 1 : 200

Dato boret :10.09.2019

Borhull 104

Posisjon: X 8682115.37 Y 514913.48

Tegner

Dato:

Kontrollert

Godkjent

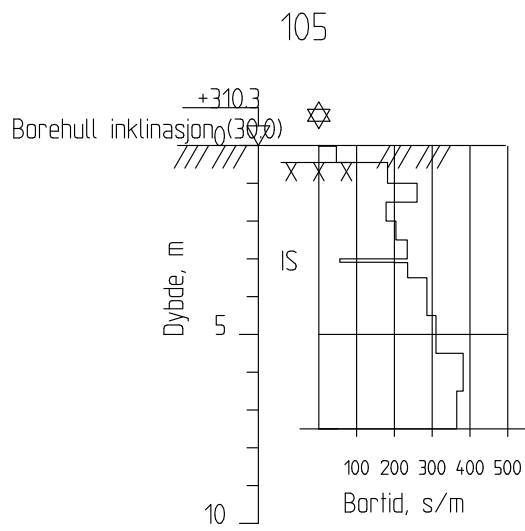

## Støtteforbygninger Sukkertoppen

Rapport nr.

Figur nr.

Fjellkontrollboring

M = 1 : 200

Dato boret :10.09.2019

Borhull 105

Posisjon: X 8682093.87 Y 514885.28

Tegner

Dato:

Kontrollert

Godkjent

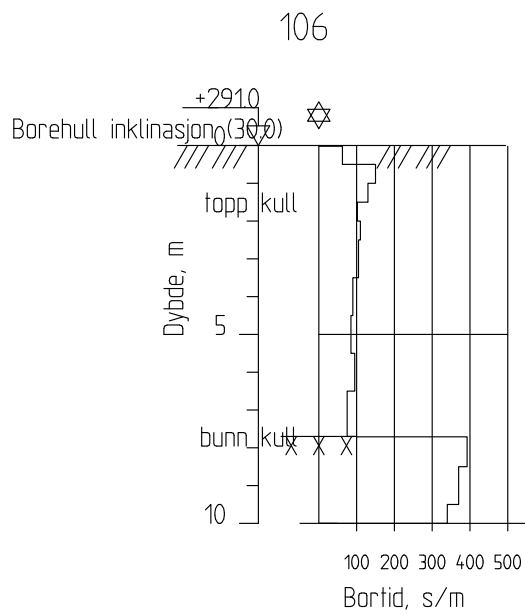

## Støtteforbygninger Sukkertoppen

Rapport nr.

Figur nr.

Fjellkontrollboring

M = 1 : 200

Dato boret :11.09.2019

Borhull 106

Posisjon: X 8682145.24 Y 514910.34

Tegner

Dato:

Kontrollert

Godkjent

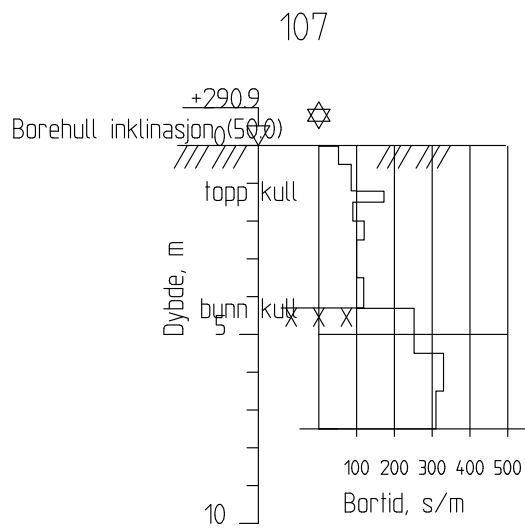

## Støtteforbygninger Sukkertoppen

Rapport nr.

Figur nr.

Fjellkontrollboring

M = 1 : 200

Dato boret :13.09.2019

Borhull 107

Posisjon: X 8682121.32 Y 514873.40

Tegner

Dato:

Kontrollert

Godkjent

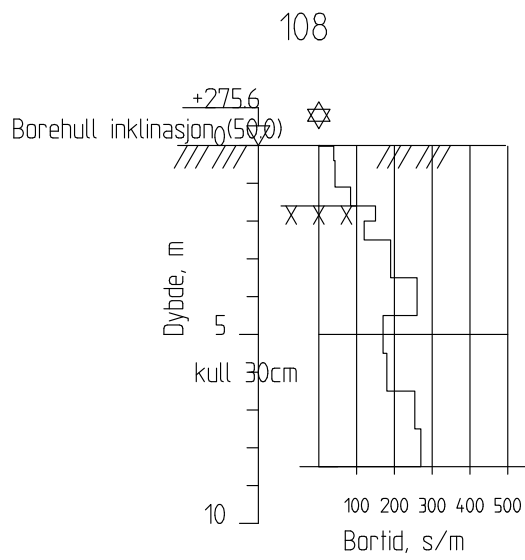

## Støtteforbygninger Sukkertoppen

Rapport nr.

Figur nr.

Fjellkontrollboring

M = 1 : 200

Dato boret :17.09.2019

Borhull 108

Posisjon: X 8682170.40 Y 514905.88

Tegner

Dato:

Kontrollert

Godkjent

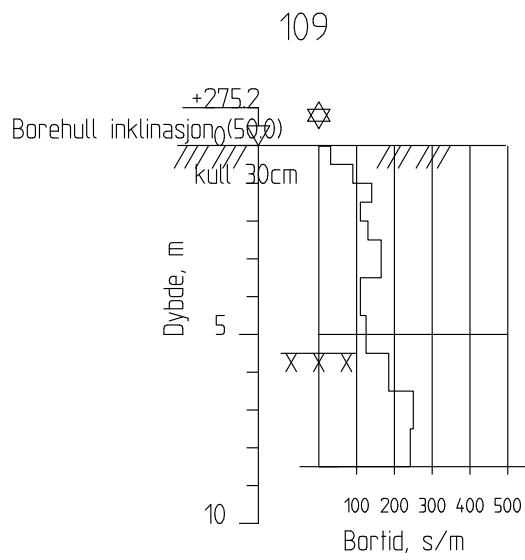

## Støtteforbygninger Sukkertoppen

Rapport nr.

Figur nr.

Fjellkontrollboring

M = 1 : 200

Dato boret :12.09.2019

Borhull 109

Posisjon: X 8682155.10 Y 514881.56

Tegner

Dato:

Kontrollert

Godkjent

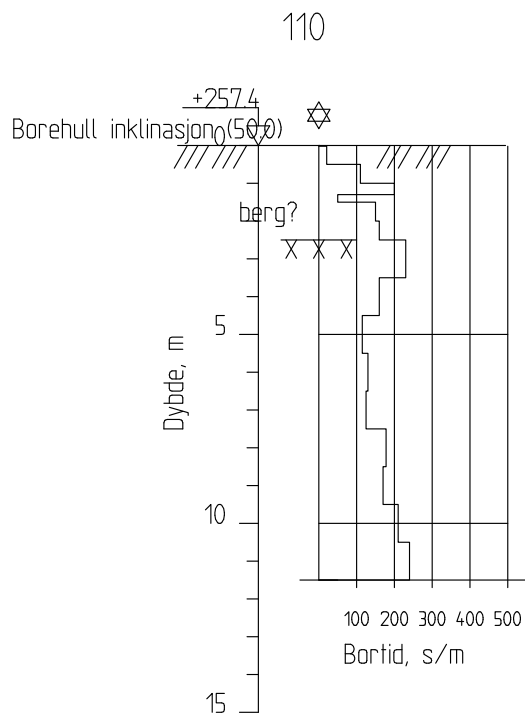

## Støtteforbygninger Sukkertoppen

Rapport nr.

Figur nr.

Fjellkontrollboring

M = 1 : 200

Dato boret :18.09.2019

Borhull 110

Posisjon: X 8682195.69 Y 514896.75

Tegner

Dato:

Kontrollert

Godkjent



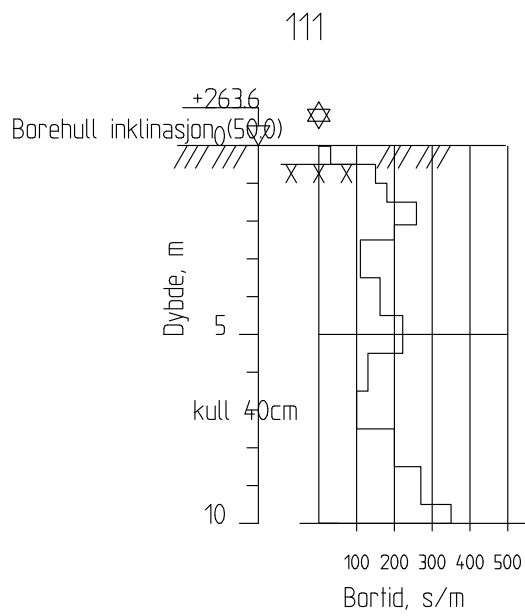

## Støtteforbygninger Sukkertoppen

Rapport nr.

Figur nr.

Fjellkontrollboring

M = 1 : 200

Dato boret :17.09.2019

Borhull 111

Posisjon: X 8682154.77 Y 514846.02

Tegner

Dato:

Kontrollert

Godkjent

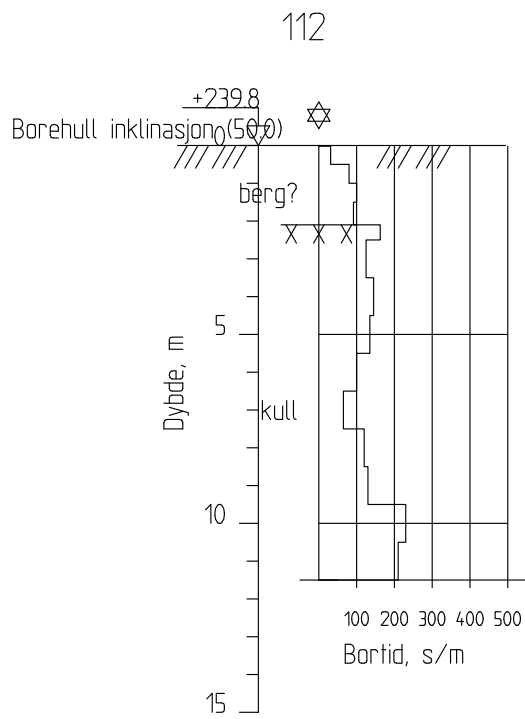

## Støtteforbygninger Sukkertoppen

Rapport nr.

Figur nr.

Fjellkontrollboring

M = 1 : 200

Dato boret :18.09.2019

Borhull 112

Posisjon: X 8682224.40 Y 514888.49

Tegner

Dato:

Kontrollert

Godkjent

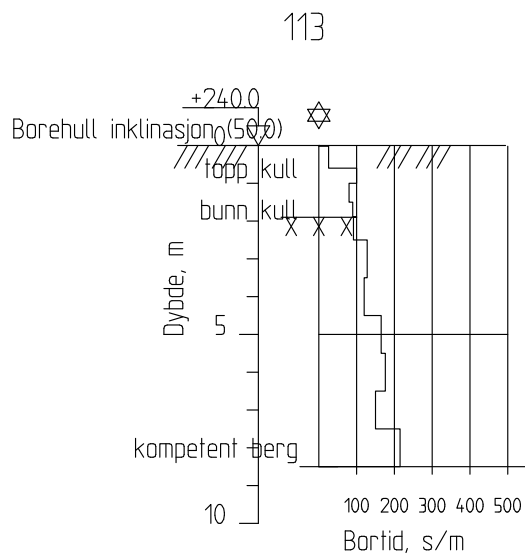

## Støtteforbygninger Sukkertoppen

Rapport nr.

Figur nr.

Fjellkontrollboring

M = 1 : 200

Dato boret :18.09.2019

Borhull 113

Posisjon: X 8682194.11 Y 514831.66

Tegner

Dato:

Kontrollert

Godkjent

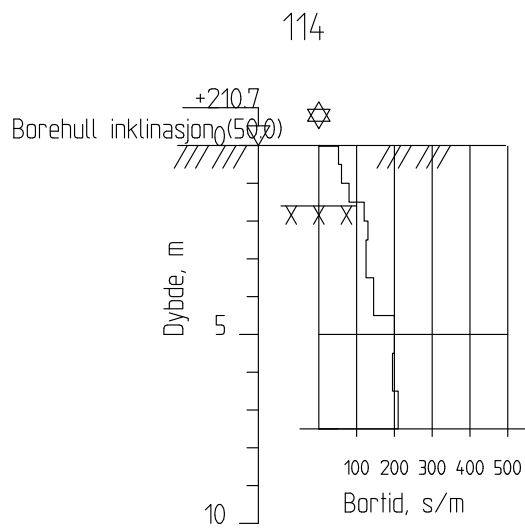

## Støtteforbygninger Sukkertoppen

Rapport nr.

Figur nr.

Fjellkontrollboring

M = 1 : 200

Dato boret :19.09.2019

Borhull 114

Posisjon: X 8682248.45 Y 514806.55

Tegner

Dato:

Kontrollert

Godkjent

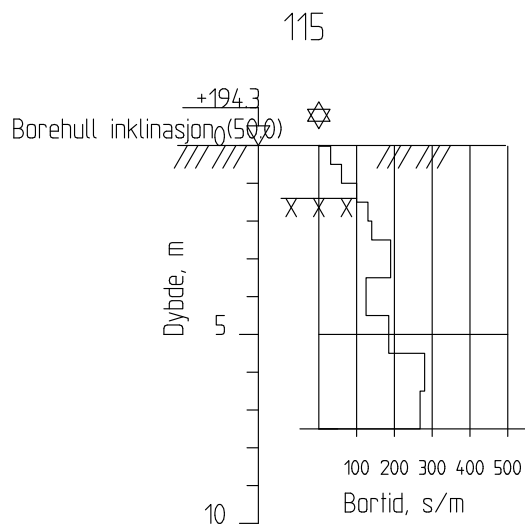

## Støtteforbygninger Sukkertoppen

Rapport nr.

Figur nr.

Fjellkontrollboring

M = 1 : 200

Dato boret :19.09.2019

Borhull 115

Posisjon: X 8682305.60 Y 514839.25

Tegner

Dato:

Kontrollert

Godkjent

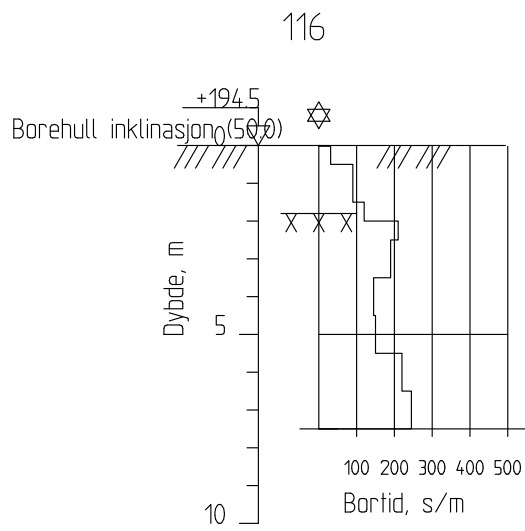

## Støtteforbygninger Sukkertoppen

Rapport nr.

Figur nr.

Fjellkontrollboring

M = 1 : 200

Dato boret :19.09.2019

Borhull 116

Posisjon: X 8682273.42 Y 514789.87

Tegner

Dato:

Kontrollert

Godkjent

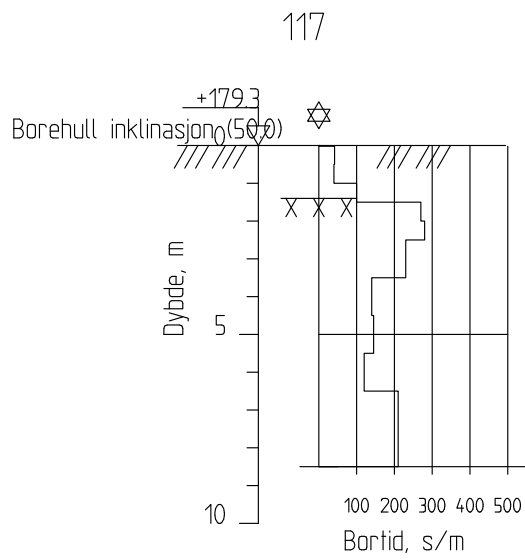

## Støtteforbygninger Sukkertoppen

Rapport nr.

Figur nr.

Fjellkontrollboring

M = 1 : 200

Dato boret :20.09.2019

Borhull 117

Posisjon: X 8682318.48 Y 514815.18

Tegner

Dato:

Kontrollert

Godkjent

118

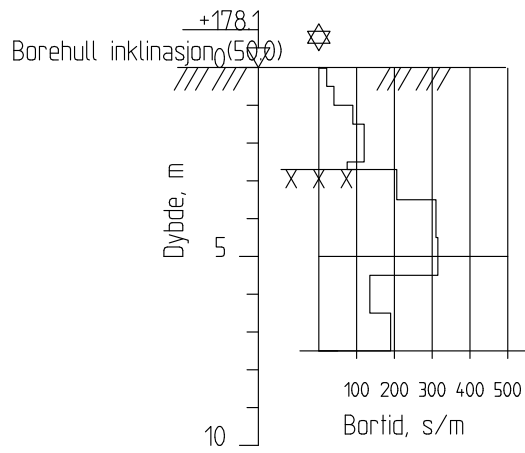

Støtteforbygninger Sukkertoppen

Rapport nr.

Figur nr.

Fjellkontrollboring

M = 1 : 200

Dato boret :20.09.2019

Borhull 118

Posisjon: X 8682288.04 Y 514763.69

Tegner

Dato:

Kontrollert

Godkjent



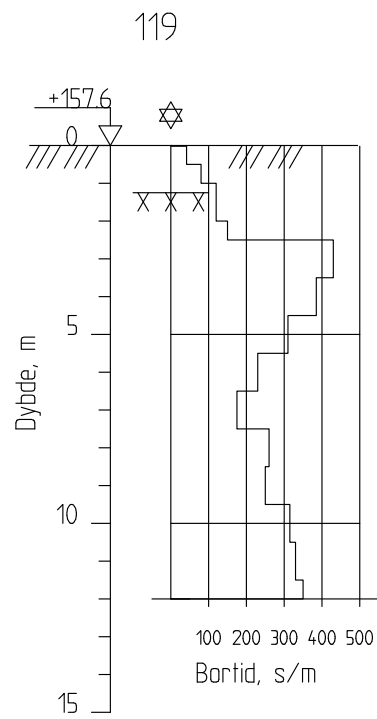

# Støtteforbygninger Sukkertoppen

Rapport nr.

Figur nr.

Fjellkontrollboring

M = 1 : 200

Dato boret :23.09.2019

Borhull 119

Posisjon: X 8682346.65 Y 514789.45

Tegner

Dato:

Kontrollert

Godkjent

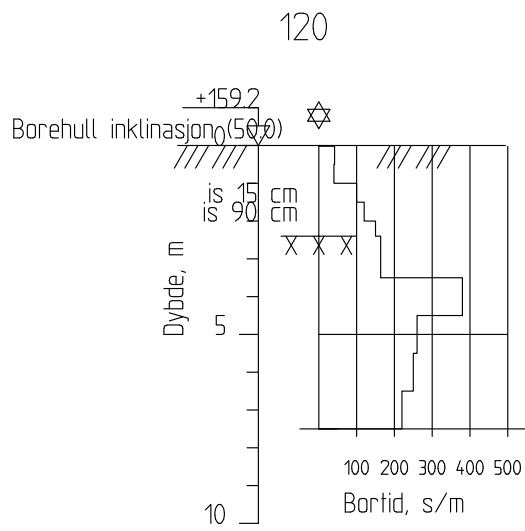

## Støtteforbygninger Sukkertoppen

Rapport nr.

Figur nr.

Fjellkontrollboring

M = 1 : 200

Dato boret :25.09.2019

Borhull 120

Posisjon: X 8682308.52 Y 514741.17

Tegner

Dato:

Kontrollert

Godkjent

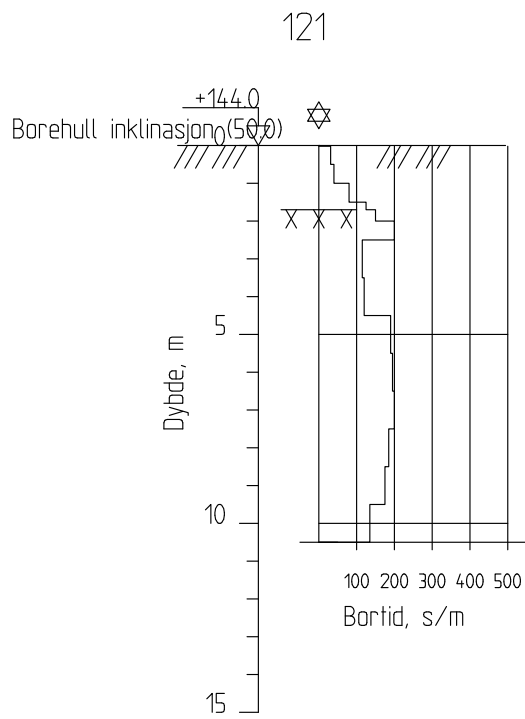

## Støtteforbygninger Sukkertoppen

Rapport nr.

Figur nr.

Fjellkontrollboring

M = 1 : 200

Dato boret :23.09.2019

Borhull 121

Posisjon: X 8682363.81 Y 514770.31

Tegner

Dato:

Kontrollert

Godkjent

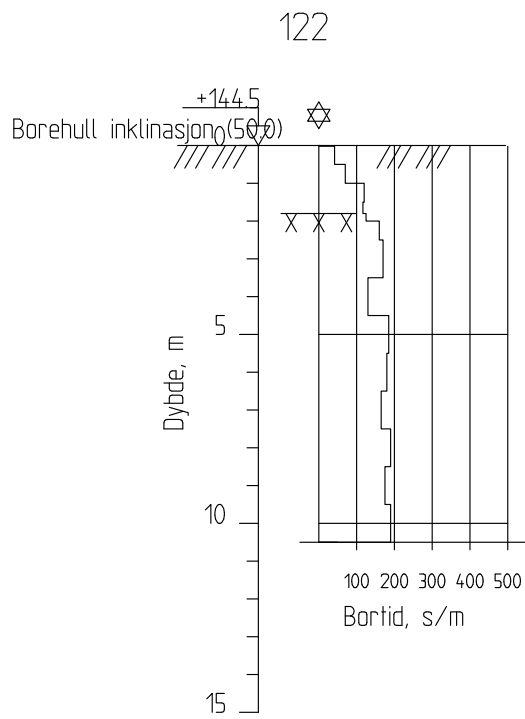

## Støtteforbygninger Sukkertoppen

Rapport nr.

Figur nr.

Fjellkontrollboring

M = 1 : 200

Dato boret :24.09.2019

Borhull 122

Posisjon: X 8682323.92 Y 514724.82

Tegner

Dato:

Kontrollert

Godkjent

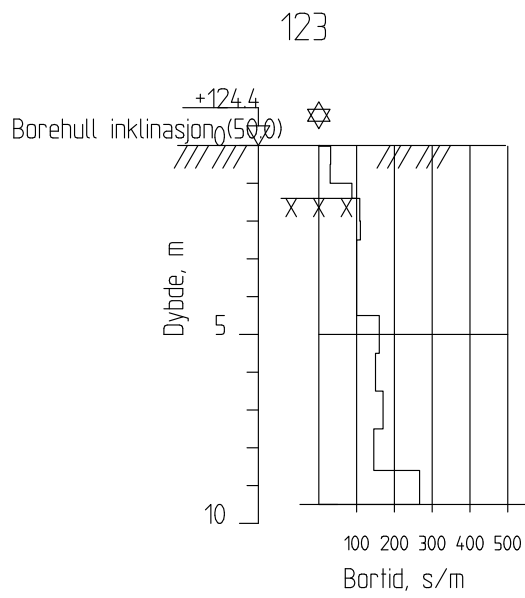

## Støtteforbygninger Sukkertoppen

Rapport nr.

Figur nr.

Fjellkontrollboring

M = 1 : 200

Dato boret :24.09.2019

Borhull 123

Posisjon: X 8682389.53 Y 514755.49

Tegner

Dato:

Kontrollert

Godkjent

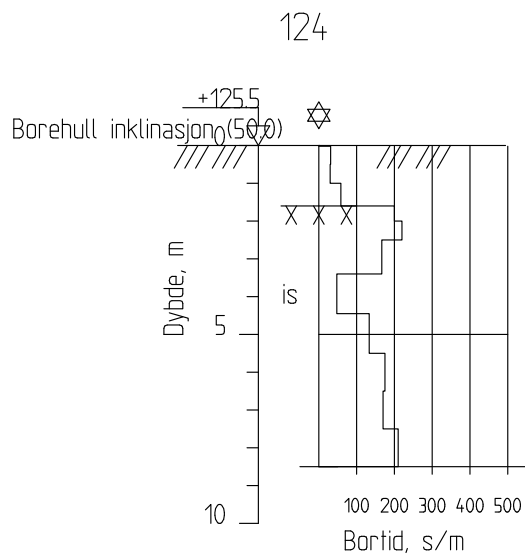

## Støtteforbygninger Sukkertoppen

Rapport nr.

Figur nr.

Fjellkontrollboring

M = 1 : 200

Dato boret :24.09.2019

Borhull 124

Posisjon: X 8682346.21 Y 514706.77

Tegner

Dato:

Kontrollert

Godkjent

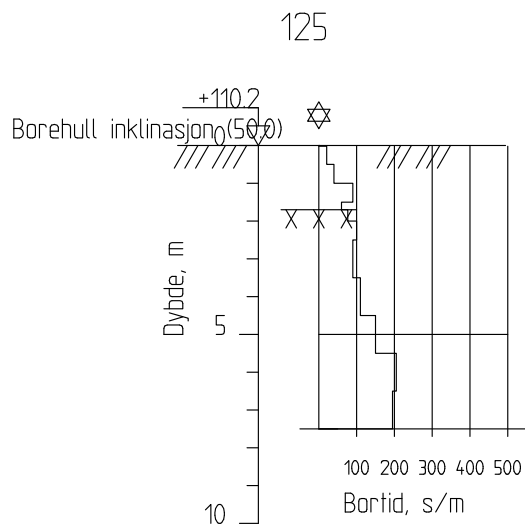

## Støtteforbygninger Sukkertoppen

Rapport nr.

Figur nr.

Fjellkontrollboring

M = 1 : 200

Dato boret :24.09.2019

Borhull 125

Posisjon: X 8682402.01 Y 514737.24

Tegner

Dato:

Kontrollert

Godkjent

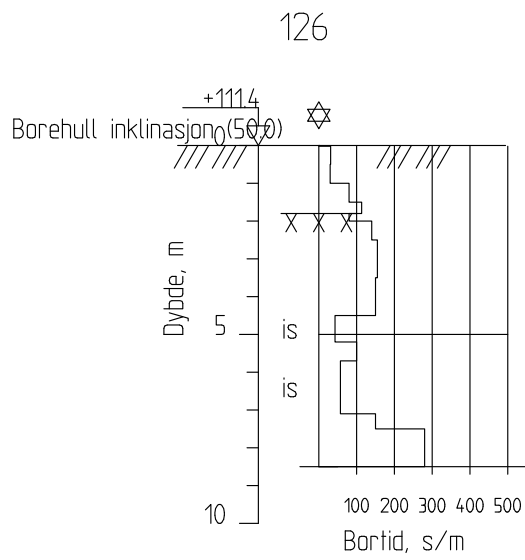

# Støtteforbygninger Sukkertoppen

Rapport nr.

Figur nr.

Fjellkontrollboring

M = 1 : 200

Dato boret :25.09.2019

Borhull 126

Posisjon: X 8682357.97 Y 514687.01

Tegner

Dato:

Kontrollert

Godkjent



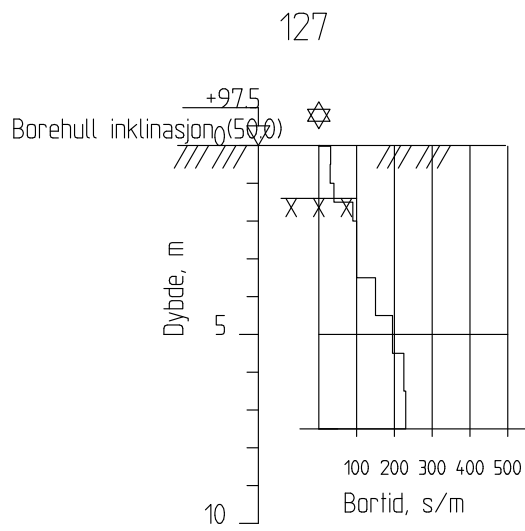

## Støtteforbygninger Sukkertoppen

Rapport nr.

Figur nr.

Fjellkontrollboring

M = 1 : 200

Dato boret :25.09.2019

Borhull 127

Posisjon: X 8682418.19 Y 514724.19

Tegner

Dato:

Kontrollert

Godkjent

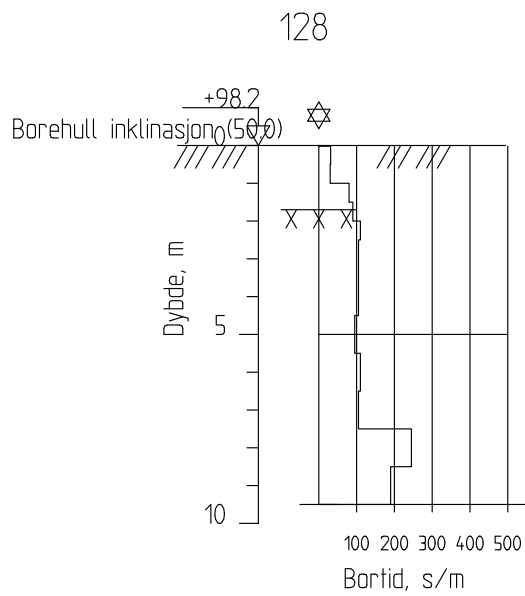

# Støtteforbygninger Sukkertoppen

Rapport nr.

Figur nr.

Fjellkontrollboring

M = 1 : 200

Dato boret :25.09.2019

Borhull 128

Posisjon: X 8682375.21 Y 514675.12

Tegner

Dato:

Kontrollert

Godkjent

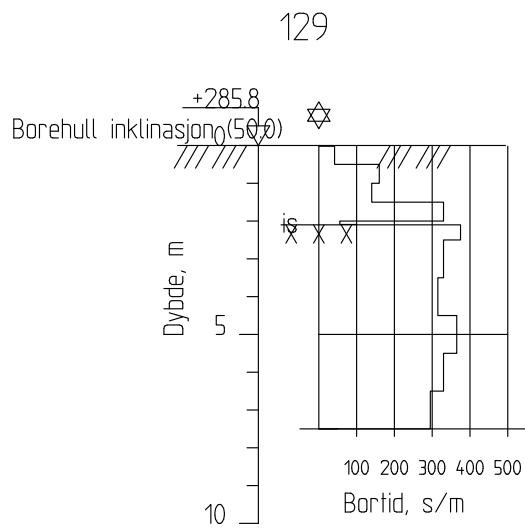

# Støtteforbygninger Sukkertoppen

Rapport nr.

Figur nr.

Fjellkontrollboring

M = 1 : 200

Dato boret :11.09.2019

Borhull 129

Posisjon: X 8682127.84 Y 514869.56

Tegner

Dato:

Kontrollert

Godkjent

STATENS VEGVESEN

**Fjellkontrollboring**

Blankett nr. 450

Sted *TP 100*



Dato *6.09.2019*

Oppdragsnr.

Sign. *[Signature]*

Hull

Terrengkote

*NEW  
HAMMER!*

Dybde i meter	Last i kg.	Ant. halve omdr.	Anm.	Dybde i meter	Last i kg.	Ant. halve omdr.	Anm.
0				15			
			<i>20 sec SOIL</i>				
1			<i>2 min 20 sec ROCK</i>	16			
			<i>2 min 10 sec ROCK</i>				
2			<i>2 min 32 sec ROCK</i>	17			
			<i>2 min 50 sec ROCK</i>				
3			<i>6 min ROCK</i>	18			
			<i>22 sec</i>				
4			<i>ROCK</i>	19			
			<i>5 min</i>				
			<i>14 sec</i>				
5			<i>ROCK</i>	20			
			<i>20 sec CRACK AFTER!</i>				
			<i>3 min</i>				
6			<i>ROCK</i>	21			
			<i>5 min</i>				
			<i>50 sec</i>				
7			<i>ROCK</i>	22			
			<i>5 min</i>				
			<i>57 sec</i>				
8				23			
9				24			
10				25			
11				26			
12				27			
13				28			
14				29			
15				30			

STATENS VEGVESEN

## Fjellkontrollboring

G

Blankett nr. 450

Sted TP 101

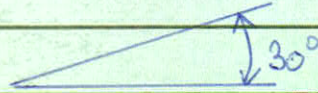

Dato 5.09.2019

Oppdragsnr.

Sign. *R. K. Mathiasen*

Hull

Terrengkote

Dybde i meter	Last i kg.	Ant. halve omdr.	Anm.	Dybde i meter	Last i kg.	Ant. halve omdr.	Anm.
0			Zone SOK	15			
1			5 min 50 sec ROCK	16			
2			6 min 10 sec ROCK	17			
3			7 min 18 sec ROCK	18			
4			11 min 50 sec ROCK	19			
5			17 min 42 sec ROCK	20			
6			16 min 35 sec ROCK	21			
7			16 min 48 sec ROCK	22			
8			17 min 16 sec ROCK	23			
9			8 min 50 sec ROCK	24			
10				25			
11				26			
12				27			
13				28			
14				29			
15				30			

STATENS VEGVESEN

## Fjellkontrollboring

Blankett nr. 450

Sted TP 102

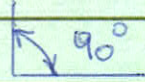

Dato 6.09.2019

Oppdragsnr.

Sign. Kjetil Mathisen

Hull

Terrengkote

Dybde i meter	Last i kg.	Ant. halve omdr.	Anm.	Dybde i meter	Last i kg.	Ant. halve omdr.	Anm.
0			15 sec SOIL	15			
1			45 sec SOFT ROCK	16			PERHAFROST
			1 min 35 sec SOFT ROCK				
2			1 min 16 sec SOFT ROCK	17			
			1 min 24 sec SOFT ROCK				
3			5 min 15 sec ROCK	18			
4			6 min 1 sec ROCK	19			
5			6 min 11 sec ROCK	20			
6			5 min 35 sec ROCK	21			
7			7 min 12 sec ROCK	22			
8			7 min 8 sec ROCK	23			
9			7 min 22 sec ROCK	24			
10			5 min 53 sec ROCK	25			
11			5 min 42 sec ROCK	26			
12			3 min 52 sec ROCK	27			
13				28			
14				29			
15				30			

STATENS VEGVESEN

## Fjellkontrollboring

Blankett nr. 450

Sted TP 103

Dato 7.09.2019

Oppdragsnr.

Sign. *[Signature]*

Hull

Terrengkote

Dybde i meter	Last i kg.	Ant. halve omdr.	Anm.	Dybde i meter	Last i kg.	Ant. halve omdr.	Anm.
0			Zonec SOIL	15			
1			1 min 20 sec PERMAFROST	16			
			1 min 40 sec PERMAFROST				
2			1 min 50 sec ROCK	17			
			2 min 20 sec ROCK				
3			5 min 20 sec ROCK	18			
4			4 min 50 sec ROCK	19			
5			5 min 25 sec SOFT ROCK	20			
			6 min 9 sec ROCK				
6				21			
7			5 min 6 sec ROCK	22			
8				23			
9				24			
10				25			
11				26			
12				27			
13				28			
14				29			
15				30			

STATENS VEGVESEN

## Fjellkontrollboring

Blankett nr. 450

Sted TP 104

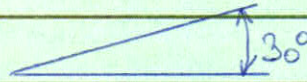

Dato 10.09.2019

Oppdragsnr.

Sign.

Hull

Terrengkote

Dybde i meter	Last i kg.	Ant. halve omdr.	Anm.	Dybde i meter	Last i kg.	Ant. halve omdr.	Anm.
0			SOIL	15			
		15 sec					
			AFTER 0,4m				
1		1 min 30 sec	ROCK	16			
		2 min 19 sec					
2		2 min 35 sec		17			
		2 min 44 sec					
3		4 min		18			
		22 sec					
4		5 min		19			
		59 sec					
5		7 min 8 sec		20			
6		5 min		21			
		38 sec					
7		6 min		22			
		25 sec					
8				23			
9				24			
10				25			
11				26			
12				27			
13				28			
14				29			
15				30			



STATENS VEGVESEN

**Fjellkontrollboring**

Blankett nr. 450

Sted *TP 105*

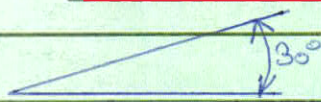

Dato *10.09.2019*

Oppdragsnr.

Sign. *[Signature]*

Hull

Terrengkote

Dybde i meter	Last i kg.	Ant. halve omdr.	Anm.	Dybde i meter	Last i kg.	Ant. halve omdr.	Anm.
0			45cm SOIL 20 sec	15			
1			1 min 40 sec ROCK	16			
2			2 min 10 sec ROCK	17			
3			1 min 29 sec PERMA FROST	18			
4			1 min 42 sec PERMA FROST	19			
5			PERMA FROST	20			
6			3 min 34 sec ROCK	21			
7			ROCK	22			
8			4 min 46 sec ROCK	23			
9			ROCK	24			
10			5 min 10 sec ROCK	25			
11			ROCK	26			
12			6 min 22 sec ROCK	27			
13			ROCK	28			
14			6 min 5 sec ROCK	29			
15				30			

→ ICE

STATENS VEGVESEN

## Fjellkontrollboring

G

Blankett nr. 450

Sted TP 106

Dato 11.09.2019

Oppdragsnr.

Sign. Kjetil Skjolden

Hull

Terrengkote

Dybde i meter	Last i kg.	Ant. halve omdr.	Anm.	Dybde i meter	Last i kg.	Ant. halve omdr.	Anm.
0			30 sec SOIL	15			
1			1 min 15 sec PERIT-FROST	16			
			1 min 50 sec PERIT-FROST				
2			50 sec COAL	17			
			55 sec COAL				
3			1 min 45 sec	18			
			COAL				
4			1 min 30 sec	19			
			COAL				
5			1 min 25 sec	20			
			COAL				
6			1 min 35 sec	21			
			COAL				
7			1 min 30 sec	22			
			COAL				
8			XX ROCK	23			
			5 min 10 sec				
9			6 min 10 sec	24			
			2 min 50 sec				
10				25			
11				26			
12				27			
13				28			
14				29			
15				30			

STATENS VEGVESEN

**Fjellkontrollboring**

Blankett nr. 450

Sted **TP 107**

Dato **11.09.2019**

Oppdragsnr.

Sign. *Klotz Mathias*

Hull

Terrengkote

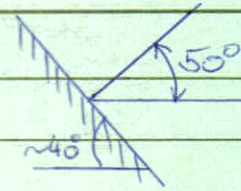

TIMES CAN NOT BE MEASURED CORRECTLY  
 DUE TO THE BAD DRILLING CONDITIONS  
 BLOWING OUT THE HOLE IS NECESSARY, OTHERWISE  
 THE DRILLING HAMMER WILL GET STUCK!!

Dybde i meter	Last i kg.	Ant. halve omdr.	Anm.	Dybde i meter	Last i kg.	Ant. halve omdr.	Anm.
0			25 sec SOIL	15			
1			~1 min PERMAFROST ~5 sec COAL	16			
2			~45 sec COAL ~1 min COAL	17			
3			~1 min COAL ~1 min 40 sec	18			
4			~1 min 35 sec COAL XX XX ROCK	19			
5			~5 min	20			
6			~5 min 30 sec	21			
7			~5 min 10 sec	22			
8				23			
9				24			
10				25			
11				26			
12				27			
13				28			
14				29			
15				30			

STATENS VEGVESEN

**Fjellkontrollboring**

Blankett nr. 450

Sted *TP 108*

Dato *17.09.2019*

Oppdragsnr.

Sign. *[Signature]*

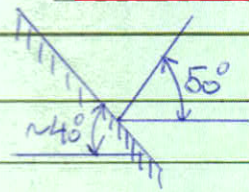

Hull

Terrengkote

Dybde i meter	Last i kg.	Ant. halve omdr.	Anm.	Dybde i meter	Last i kg.	Ant. halve omdr.	Anm.
0		15sec	FROZEN SOIL	15			IT IS HARD TO TELL!??
1		30sec	PERMA FROST/ FROZEN SOIL	16			
		42sec	PERMA FROST/ FROZEN SOIL				
2		1min	Soft Rock	17			
		1min	Soft Rock				
3		3min	layers of soft and solid rocks	18			
		10sec					
4		4min	layers of soft and solid rocks	19			
		20sec					
5		2min	layers of soft and solid rocks	20			
		50sec					
6		3min	bed rock	21			
			soft rock				
7		4min	--- CRACK IN THE ROCK	22			
		15sec					
8		4min		23			
		30sec					
9				24			
10				25			
11				26			
12				27			
13				28			
14				29			
15				30			

STATENS VEGVESEN

**Fjellkontrollboring**

Blankett nr. 450

Sted *TP 109*

Dato *12.09.2019*

Oppdragsnr.

Sign. *Kate Mathias*

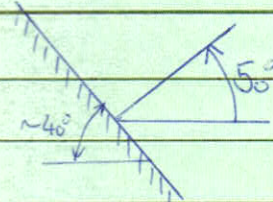

Hull

Terrengkote

Dybde i meter	Last i kg.	Ant. halve omdr.	Anm.	Dybde i meter	Last i kg.	Ant. halve omdr.	Anm.
0				15			
		15 sec	SOIL				
		45 sec	COAL				
1		1 min 10 sec	PERMA-FROST	16			
		55 sec	PERMA-FROST				
2		1 min 50 sec	PERMA-FROST	17			
		2 min	PERMA-FROST				
3		45 sec	FROST	18			
		1 min	PERMA-FROST				
4		50 sec	FROST	19			
		2 min	PERMA-FROST				
5		5 sec	FROST	20			
		3 min	SOFT ROCK				
6		5 sec	BUT STILL A BIT BROWN DUST	21			
		4 min	ROCK				
7		10 sec		22			
		4 min 20 sec	ROCK				
8				23			
9				24			
10				25			
11				26			
12				27			
13				28			
14				29			
15				30			

DRILLING 8,5m DUE TO THE SOFT ROCK AT 5,5m.

STATENS VEGVESEN

**Fjellkontrollboring**

Blankett nr. 450

Sted TP 129 - ADDITIONAL

Dato 11.09.2019

Oppdragsnr.

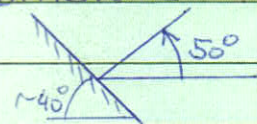

Sign. [Signature]

Hull

Terrengkote

Dybde i meter	Last i kg.	Ant. halve omdr.	Anm.	Dybde i meter	Last i kg.	Ant. halve omdr.	Anm.
0				15			
			20 sec SOIL				
			SOIL				
1			1 min 20 PERMA-FROST	16			
			1 min 10 PERMA-FROST				
2			2 min 45 ROCK	17			
			XXX ROCK				
			2 min 30 sec				
3			5 min 30 sec	18			
4			5 min 15	19			
5			6 min 5 sec	20			
6			5 min 30 sec	21			
7			4 min 55 sec	22			
8				23			
9				24			
10				25			
11				26			
12				27			
13				28			
14				29			
15				30			

ICE

STATENS VEGVESEN

**Fjellkontrollboring**

Blankett nr. 450

Sted *TP 110*

Dato *18.09.2019*

Oppdragsnr.

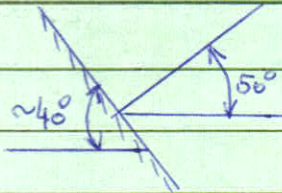

Sign. *Wolke Hollium*

Hull

Terrengkote

Dybde i meter	Last i kg.	Ant. halve omdr.	Anm.	Dybde i meter	Last i kg.	Ant. halve omdr.	Anm.
0				15			
		10sec	Frozen Soil				
1		55sec	Frozen Soil	16			
		1min					
		10sec	Soft Rock				
2		1min 15sec		17			
		1min 20sec					
		XXX	Rock				
3		3min 50sec		18			
		2min 40					
4		1min 55sec	Soft Rock	19			
		2min 10sec					
5		2min 50sec		20			
		2min 58sec	Rock				
6		2min 50sec	Soft Rock	21			
		3min 30sec	Rock				
7		4min		22			
8				23			
9				24			
10				25			
11				26			
12				27			
13				28			
14				29			
15				30			

STATENS VEGVESEN

**Fjellkontrollboring**

Blankett nr. 450

Sted *TP 111*

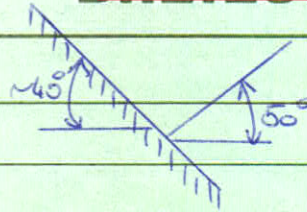

Dato *17.09.2019*

Oppdragsnr.

Sign. *[Signature]*

Hull

Terrengkote

Dybde i meter	Last i kg.	Ant. halve omdr.	Anm.	Dybde i meter	Last i kg.	Ant. halve omdr.	Anm.
0			Frozen Soil	15			
1			Soft Rock	16			
2			Rock	17			
3			Soft Rock	18			
4			Peena Frost / Frozen soil	19			
5			Soft Rock	20			
6			Soft Rock	21			
7			Soft Rock	22			
8			Coal / Rock	23			
9			xxxx	24			layer of soft Rock
10				25			
11				26			
12				27			
13				28			
14				29			
15				30			



STATENS VEGVESEN

**Fjellkontrollboring**

Blankett nr. 450

Sted *TP 112*

Dato *18.09.2019*

Oppdragsnr.

Sign. *[Signature]*

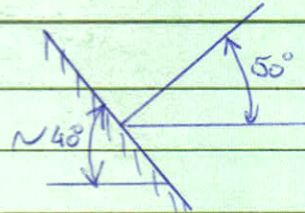

Hull

Terrengekote

Dybde i meter	Last i kg.	Ant. halve omdr.	Anm.	Dybde i meter	Last i kg.	Ant. halve omdr.	Anm.
0				15			
			15sec Soil				
1			~40sec Soil	16			
			50sec				
2			55sec	17			
			1min 5sec Soft Rock				
3			2min Soft Rock	18			
			5sec				
4			2min Soft Rock	19			
			25sec				
5			2min Soft Rock	20			
			15sec				
6			1min Soft Rock	21			
			40sec				
7			1min local	22			
			5sec				
8			2min Soft Rock	23			
9			2min Soft-Rock	24			
			10				
			xxx				
10			3min Solid Rock	25			
			50sec				
11			3min	26			
			30sec				
12				27			
13				28			
14				29			
15				30			

→ local

Bl. nr. 450 10.000 01-01

STATENS VEGVESEN

**Fjellkontrollboring**

Blankett nr. 450

Sted **TP113**

Dato **18.09.2019**

Oppdragsnr.

Sign. *[Signature]*

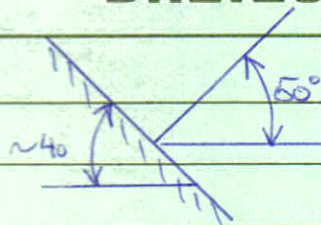

Hull

Terrengkote

Dybde i meter	Last i kg.	Ant. halve omdr.	Anm.	Dybde i meter	Last i kg.	Ant. halve omdr.	Anm.
0				15			
			15 sec Soil				
1			40 sec loal	16			
			40 sec				
2			35 sec loal	17			
			55 sec				
3			2 min 8 sec	18			
4			2 min	19			
							Soft Rock
5			2 min 45 sec	20			
6			2 min 50 sec	21			
7			2 min 30 sec	22			
8			3 min <sup>xxx</sup> 35 sec	23			
							Swish Rock
9				24			
10				25			
11				26			
12				27			
13				28			
14				29			
15				30			

STATENS VEGVESEN

**Fjellkontrollboring**

Blankett nr. 450

Sted *TP 114*

Dato *19.09.2019*

Oppdragsnr.

Sign. *Abbe Mathias*

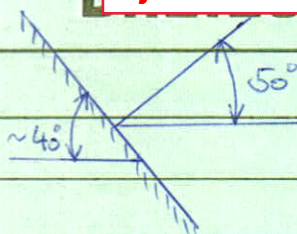

Hull

Terrengkode

Dybde i meter	Last i kg.	Ant. halve omdr.	Anm.	Dybde i meter	Last i kg.	Ant. halve omdr.	Anm.
0				15			
		<i>~25 sec</i>	<i>Soil with stones</i>				
1		<i>30 sec</i>	<i>-u-</i>	16			
		<i>40 sec</i>	<i>-u-</i>				
2		<i>1 min<sup>xxx</sup></i>	<i>Soft Rock</i>	17			
		<i>1 min<sup>5</sup></i>					
3		<i>2 min</i>		18			
		<i>5 sec</i>					
4		<i>2 min</i>		19			
		<i>25 sec</i>					
5		<i>3 min</i>		20			
		<i>20 sec</i>					
6		<i>3 min</i>		21			
		<i>15 sec</i>					
7		<i>3 min</i>		22			
		<i>30 sec</i>					
8				23			
9				24			
10				25			
11				26			
12				27			
13				28			
14				29			
15				30			

*20cm layer with very hard rocks*

Bl. nr. 450 10.000 01-01

STATENS VEGVESEN

**Fjellkontrollboring**

Blankett nr. 450

Sted *TP 115*

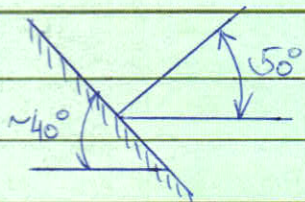

Dato *19.09.2019*

Oppdragsnr.

Sign. *Kbte Ustohian*

Hull

Terrengkote

Dybde i meter	Last i kg.	Ant. halve omdr.	Anm.	Dybde i meter	Last i kg.	Ant. halve omdr.	Anm.
0			<i>15 sec Soil and loose Stones</i>	15			
1			<i>20 sec - n -</i>	16			
			<i>50 sec - n -</i>				
2			<i>1 min 5 sec Soft Rock</i>	17			
			<i>1 min 10 sec - n -</i>				
3			<i>3 min solid-Rock</i>	18			
4			<i>2 min layers of soft and solid Rock</i>	19			<i>soft-Rock</i>
			<i>xxx solid Rock</i>				
5			<i>3 min 5 sec</i>	20			
6			<i>4 min - n -</i>	21			
			<i>40 sec</i>				
7			<i>4 min - n -</i>	22			
			<i>28 sec</i>				
8				23			
9				24			
10				25			
11				26			
12				27			
13				28			
14				29			
15				30			

STATENS VEGVESEN

**Fjellkontrollboring**

Blankett nr. 450

Sted *TP 116*

Dato *19.09.2019*

Oppdragsnr.

Sign. *W. Mathisen*

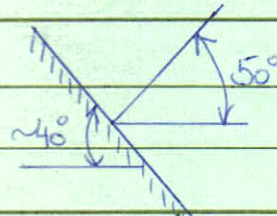

Hull

Terrengkote

Dybde i meter	Last i kg.	Ant. halve omdr.	Anm.	Dybde i meter	Last i kg.	Ant. halve omdr.	Anm.
0				15			
			<i>15 sec Soil and Stones</i>				
1			<i>45 sec -u-</i>	16			
			<i>45 min -u-</i>				
2			<i>1 min xxx Soft Rock</i>	17			
			<i>1 min 45 sec</i>				
3			<i>3 min -u-</i>	18			
			<i>10 sec</i>				
4			<i>2 min -u-</i>	19			
			<i>25 sec</i>				
5			<i>2 min -u-</i>	20			
			<i>30 sec -u-</i>				
6			<i>3 min xxx</i>	21			
			<i>40 sec Solid-Rock</i>				
7			<i>4 min</i>	22			
			<i>5 sec</i>				
8				23			
9				24			
10				25			
11				26			
12				27			
13				28			
14				29			
15				30			

*20 cm of very loose material*

STATENS VEGVESEN

**Fjellkontrollboring**

Blankett nr. 450

Sted **TP 117**

Dato **20.09.2019**

Oppdragsnr.

Sign. *[Signature]*

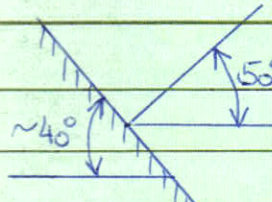

Hull

Terrengkode

Dybde i meter	Last i kg.	Ant. halve omdr.	Anm.	Dybde i meter	Last i kg.	Ant. halve omdr.	Anm.
0			loose stones + Seil	15			
1			~20sec -"-	16			
2			~50sec 2min 15sec Soft Rock	17			
3			2min 20sec -"- 3min solid Rock	18			
4			2min soft Rock	19			
5			2min layer of soft and solid Rock	20			
6			2min soft Rock	21			
7			3min solid Rock	22			
8			30sec 3min solid Rock	23			
9				24			
10				25			
11				26			
12				27			
13				28			
14				29			
15				30			

STATENS VEGVESEN

**Fjellkontrollboring**

Blankett nr. 450

Sted *TP 118*

Dato *20.09.2019*

Oppdragsnr.

Sign. *Kate Malin*

Hull

Terrengkote

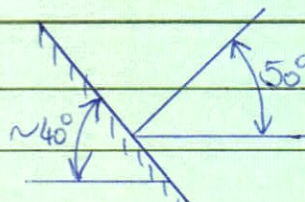

*We moved the GPS-Point about 5 m to the left.*

Dybde i meter	Last i kg.	Ant. halve omdr.	Anm.	Dybde i meter	Last i kg.	Ant. halve omdr.	Anm.
0				15			
			<i>10 sec loose stones and soil</i>				
1			<i>20 sec -H-</i>	16			
			<i>15 sec -H-</i>				
2			<i>7 min Permafrost</i>	17			
			<i>1 min</i>				
3			<i>3 min XXX</i>	18			<i>10 cm layer of ice</i>
			<i>5 min 10 sec</i>				
4				19			
			<i>5 min 15 sec</i>				
5				20			
			<i>2 min 15 sec</i>				
6				21			
			<i>3 min 10 sec</i>				
7				22			
				23			
8				24			
				25			
9				26			
				27			
10				28			
				29			
11				30			
12							
13							
14							
15							

STATENS VEGVESEN

**Fjellkontrollboring**

Blankett nr. 450

Sted *TP 119 = TG*

Dato *23.09.2019*

Oppdragsnr.

Sign. *[Signature]*

Hull

Terrengkote

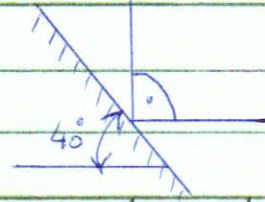

Dybde i meter	Last i kg.	Ant. halve omdr.	Anm.	Dybde i meter	Last i kg.	Ant. halve omdr.	Anm.
0				15			
			<i>20sec Soil/loose stones</i>				
1			<i>40sec - u -</i>	16			
			<i>~1min x x Soft Rock</i>				
2			<i>~1min</i>	17			
			<i>~1min/50sec</i>				
3			<i>7min</i>	18			
			<i>10sec</i>				
4			<i>6min</i>	19			
			<i>25sec</i>				
5			<i>5min</i>	20			<i>Soft Rock</i>
			<i>10sec</i>				
6			<i>3min</i>	21			
			<i>50sec</i>				
7			<i>2min</i>	22			
			<i>55sec</i>				
8			<i>4min</i>	23			
			<i>20sec</i>				
9			<i>4min</i>	24			
			<i>10sec</i>				
10			<i>5min</i>	25			
			<i>15sec</i>				
11			<i>5min</i>	26			
			<i>30sec</i>				
12			<i>2min 50sec</i>	27			
13				28			
14				29			
15				30			

Bl. nr. 450 10.000 01-01



STATENS VEGVESEN

**Fjellkontrollboring**

Blankett nr. 450

Sted *TP 120*

Dato *23.09.2019*

Oppdragsnr.

Sign. *Klote Madsen*

Hull

Terrengkote

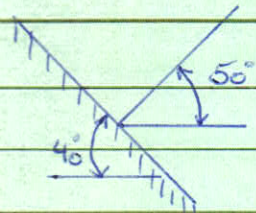

Dybde i meter	Last i kg.	Ant. halve omdr.	Anm.	Dybde i meter	Last i kg.	Ant. halve omdr.	Anm.
0				15			
1				16			
2				17			
3				18			
4				19			
5				20			
6				21			
7				22			
8				23			
9				24			
10				25			
11				26			
12				27			
13				28			
14				29			
15				30			

Bl. nr. 450 10.000 01-01

*Soil and loose stones*  
*~20 sec*  
*50 sec*  
*~1 min*  
*1 min*  
*Soft Rock*  
*3 min*  
*solid Rock*  
*6 min*  
*20 sec*  
*4 min*  
*20 sec*  
*4 min*  
*10 sec*  
*solid Rock*  
*3 min*  
*solid Rock*  
*40 sec*  
*solid Rock*

*ice*

*15cm layer of ice*

*Soil*

*soft Rock*

*soft Rock*

STATENS VEGVESEN

**Fjellkontrollboring**

Blankett nr. 450

Sted *TP 121*

Dato *23.09.2019*

Oppdragsnr.

Sign. *[Signature]*

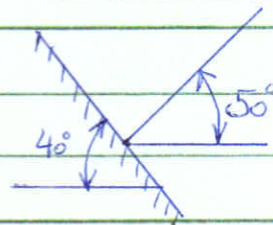

Hull

Terrengkote

Dybde i meter	Last i kg.	Ant. halve omdr.	Anm.	Dybde i meter	Last i kg.	Ant. halve omdr.	Anm.
0				15			
			<i>15sec Soil and loose stones</i>				
1			<i>20sec -H-</i>	16			
			<i>40sec -H-</i>				
2			<i>1min 10sec XXX↑</i>	17			
			<i>1min 40sec</i>				
3			<i>1min 55sec</i>	18			<i>Layer of porous rock</i>
4			<i>2min</i>	19			
5			<i>3min 10sec</i>	20			<i>soft rock</i>
6			<i>3min 15sec</i>	21			
7			<i>3min 20sec</i>	22			
8			<i>3min 50sec</i>	23			
9			<i>2min 55sec</i>	24			
10			<i>3min 15sec</i>	25			
11				26			
12				27			
13				28			
14				29			
15				30			

STATENS VEGVESEN

**Fjellkontrollboring**

Blankett nr. 450

Sted **TP 122**

Dato **24.09.2019**

Oppdragsnr.

Sign. *Kåre Mollnes*

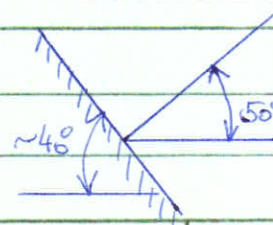

Hull

Terrengkote

Dybde i meter	Last i kg.	Ant. halve omdr.	Anm.	Dybde i meter	Last i kg.	Ant. halve omdr.	Anm.
0			soil and loose stones	15			
1			~35 sec	16			
2			~1 min xxx	17			
3			~1 min 20 sec	18			
4			2 min 50 sec	19			
5			2 min 10 sec	20			layer of frozen soil / Permafrost
6			3 min	21			
7			2 min 45 sec	22			soft rock
8			3 min 10 sec	23			
9			2 min 55 sec	24			
10			3 min 10 sec	25			
11				26			
12				27			
13				28			
14				29			
15				30			

STATENS VEGVESEN

**Fjellkontrollboring**

Blankett nr. 450

Sted **TP123**

Dato **24.09.2019**

Oppdragsnr.

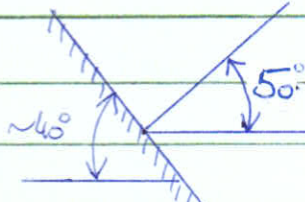

Sign.

*Rolf Mollnes*

Hull

Terrengkote

Dybde i meter	Last i kg.	Ant. halve omdr.	Anm.	Dybde i meter	Last i kg.	Ant. halve omdr.	Anm.
0			~15 sec Soil / loose Stones	15			
1			~15 sec - " -	16			
			~35 sec - " -				
2			1 min 5 sec Soft Rock	17			
			55 sec				
3			1 min 40 sec	18			
4			1 min 40 sec	19			
5			2 min 40 sec	20			
6			2 min 30 sec	21			
7			2 min 50 sec	22			
8			2 min 40 sec	23			
9			4 min solid Rock	24			
10				25			
11				26			
12				27			
13				28			
14				29			
15				30			

same kind of soft Rock over the whole distance!

STATENS VEGVESEN

**Fjellkontrollboring**

Blankett nr. 450

Sted *TP124*

Dato *24.09.2019*

Oppdragsnr.

Sign. *Kåre Holthius*

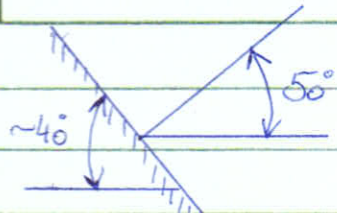

Hull

Terrengkote

Dybde i meter	Last i kg.	Ant. halve omdr.	Anm.	Dybde i meter	Last i kg.	Ant. halve omdr.	Anm.
0				15			
			<i>Soil / løse Steiner</i>				
1			<i>~15 sec</i>	16			
			<i>~35 sec</i>				
2			<i>~1 min 10 sec</i>	17			
			<i>1 min 50 sec</i>				<i>soft Rock</i>
3			<i>2 min 30 sec</i>	18			
			<i>50 sec</i>	19			<i>ice</i>
4				20			
<i>4.45</i>							
5			<i>2 min 20 sec</i>	21			<i>soft Rock</i>
			<i>2 min 55 sec</i>	22			
6			<i>2 min 50 sec</i>	23			<i>at this point, Rock turned harder</i>
			<i>3 min 30 sec</i>	24			
7				25			
				26			
8				27			
				28			
9				29			
				30			
10							
11							
12							
13							
14							
15							

Bl. nr. 450 10.000 01-01

STATENS VEGVESEN

**Fjellkontrollboring**

Blankett nr. 450

Sted *TP 125*

Dato *24.09.2019*

Oppdragsnr.

Sign. *Rolf Morken*

Hull

Terrengkote

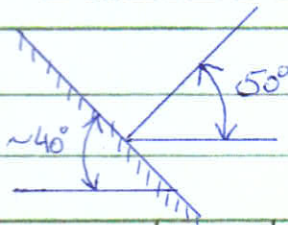

*We drilled until 7,5m due to the drilltime of the last 2m. Furthermore the Rock did not have any cracks and different layers.*

Dybde i meter	Last i kg.	Ant. halve omdr.	Anm.	Dybde i meter	Last i kg.	Ant. halve omdr.	Anm.
0				15			
1				16			
2				17			
3				18			
4				19			
5				20			
6				21			
7				22			
8				23			
9				24			
10				25			
11				26			
12				27			
13				28			
14				29			
15				30			

Bl. nr. 450 10.000 01-01

STATENS VEGVESEN

**Fjellkontrollboring**

Blankett nr. 450

Sted *TP 126*

Dato *25.09.2019*

Oppdragsnr.

Sign. *[Signature]*

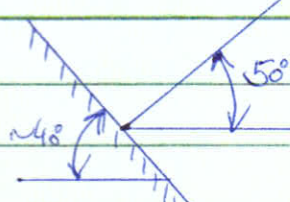

Hull

Terrengkote

Dybde i meter	Last i kg.	Ant. halve omdr.	Anm.	Dybde i meter	Last i kg.	Ant. halve omdr.	Anm.
0				15			
			<i>~15 sec Soil/loose stones</i>				
1				16			
			<i>~15 sec -u-</i>				
			<i>~40 sec -u-</i>				
2				17			
			<i>~40 sec</i>				
			<i>1 min</i>				<i>Soft Rock</i>
			<i>10 sec</i>				
3				18			
			<i>2 min</i>				
			<i>35 sec</i>				
4				19			
			<i>2 min</i>				
			<i>30 sec</i>				
5				20			
			<i>1 min</i>				<i>ice</i>
			<i>10 sec</i>				<i>Soft Rock</i>
6				21			
			<i>1 min</i>				
7				22			
			<i>1 min</i>				<i>ice</i>
			<i>40 sec</i>				<i>xxx Soft Rock</i>
8				23			
			<i>4 min</i>				<i>solid Rock</i>
			<i>40 sec</i>				
9				24			
10				25			
11				26			
12				27			
13				28			
14				29			
15				30			

Bl. nr. 450 10.000 01-01

STATENS VEGVESEN

**Fjellkontrollboring**

Blankett nr. 450

Sted **TP 127**

Dato **25.09.2019**

Oppdragsnr.

Sign. *[Signature]*

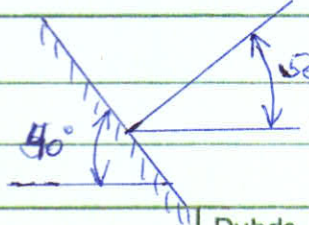

Hull

Terrengkote

Dybde i meter	Last i kg.	Ant. halve omdr.	Anm.	Dybde i meter	Last i kg.	Ant. halve omdr.	Anm.
0		15 sec	Soil / loose stones	15			
1		15 sec	- u -	16			
		20 sec	- u -				
2		45 sec	Soft Rocks	17			
		50 sec					
3		1 min		18			
		40 sec					
4		2 min		19			
		30 sec					
5		3 min		20			
		15 sec	Bedded Rock				
6		3 min		21			
		45 sec					
7		3 min		22			
		50 sec					
8				23			
9				24			
10				25			
11				26			
12				27			
13				28			
14				29			
15				30			



STATENS VEGVESEN

**Fjellkontrollboring**

Blankett nr. 450

Sted *TP 128*

Dato *25.09.2019*

Oppdragsnr.

Sign. *[Signature]*

Hull

Terrengkote

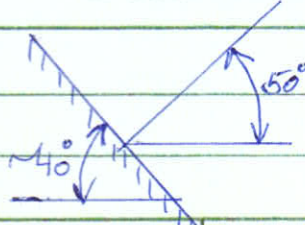

Dybde i meter	Last i kg.	Ant. halve omdr.	Anm.	Dybde i meter	Last i kg.	Ant. halve omdr.	Anm.
0				15			
			<i>Soil/loose Stones</i>				
1				16			
			<i>-u-</i>				
			<i>-u-</i>				
2				17			
			<i>xxx surf + Rock</i>				
3				18			
4				19			
5				20			
6				21			
7				22			
8				23			
			<i>solid Rock</i>				
9				24			
			<i>-u-</i>				
10				25			
11				26			
12				27			
13				28			
14				29			
15				30			

STATENS VEGVESEN

**Fjellkontrollboring**

Blankett nr. 450

Sted **T5**

Dato **25.09.2019**

Oppdragsnr.

Sign. *[Signature]*

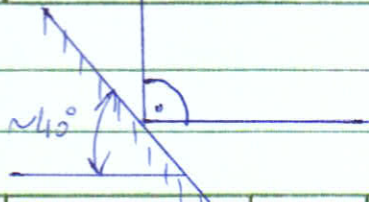

Hull

Terrengkote

Dybde i meter	Last i kg.	Ant. halve omdr.	Anm.	Dybde i meter	Last i kg.	Ant. halve omdr.	Anm.
0				15			
		25 sec	Soil / loose stones				
1		25 sec		16			
		25 sec	soft rock				
		45 sec					
2		55 sec		17			
		1 min					
		45 sec					
3		4 min	Solid Rock	18			
		40 sec					
4		2 min	layers of soft and solid rock	19			
		45 sec					
5		3 min	Solid Rock	20			
		55 sec					
6		3 min	- u -	21			
		50 sec					
7		3 min	- u -	22			
		10 sec					
8		4 min	- u -	23			
		3 min					
		50 sec					
9		4 min	- u -	24			
		3 min					
		50 sec					
10		4 min	- u -	25			
		10 sec					
11		2 min 35 sec	- u -	26			
12				27			
13				28			
14				29			
15				30			